ADVANTEST®

ADVANTEST CORPORATION

**INSTRUCTION
MANUAL**

TR4726

LOGIC ANALYZER

MANUAL NUMBER OEB01 909

Before reselling to other corporations or re-exporting to other countries, you are required to obtain permission from both the Japanese Government under its Export Control Act and the U. S. Government under its Export Control Law.

Table of Power Cable options

There are six power cable options (refer to following table).
Order power cable options by Accessory Codes.

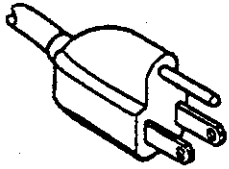
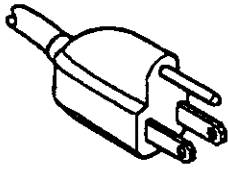
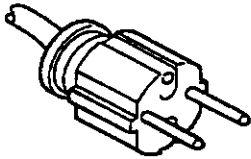
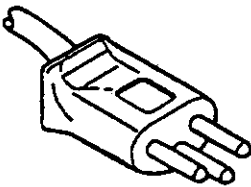
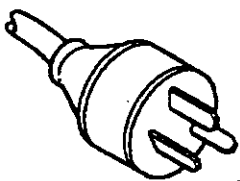
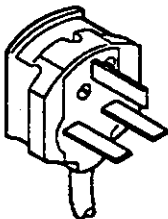
	Plug Configuration	Standards	Rating, Color and Length	Accessory Codes (Option Number)
1		JIS: Japan Law on Electrical Appliances	125V at 7A Black 2m (6ft)	Straight: A01402 (Standard) Angled: A01412
2		UL: United States of America CSA: Canada	125V at 7A Black 2m (6ft)	Straight: A01403 (Option 95) Angled: A01413
3		CEE: Europe VDE: Germany OVE: Austria SEMKO: Sweden DEMKO: Denmark KEMA: Holland FIMKO: Finland NEMKO: Norway CEBEC: Belgium	250V at 6A Gray 2m (6ft)	Straight: A01404 (Option 96) Angled: A01414
4		SEV: Switzerland	250V at 6A Gray 2m (6ft)	Straight: A01405 (Option 97) Angled: A01415
5		SAA: Australia, New Zealand	250V at 6A Gray 2m (6ft)	Straight: A01406 (Option 98) Angled: —
6		BS: United Kingdom	250V at 6A Black 2m (6ft)	Straight: A01407 (Option 99) Angled: A01417

TR4726
LOGIC ANALYZER
OPERATION MANUAL

TABLE OF CONTENTS

TABLE OF CONTENTS

1. INTRODUCTION	1 - 3
1.1 HOW TO USE THIS MANUAL	1 - 3
1.2 PRODUCT DESCRIPTION	1 - 4
1.3 BEFORE STARTING UP THE ANALYZER	1 - 5
1.3.1 Appearance Check and Attachments Check	1 - 5
1.3.2 Operating/environmental conditions and operating precautions	1 - 6
1.3.3 Connecting the power supply	1 - 7
2. ANALYSIS PREPARATIONS AND PRELIMINARY KNOWLEDGE	2 - 3
2.1 PURPOSE	2 - 3
2.2 SETTING UP THE LOGIC ANALYZER	2 - 4
2.3 DETAILED PROCEDURE FOR CONNECTING DATA ACQUISITION PROBES E AND F	2 - 5
2.4 SYSTEM SOFTWARE LOADING PROCEDURE	2 - 8
2.5 DATA INPUT METHODS FOR EACH MENU ITEM	2 - 9
2.6 PANEL DESCRIPTION	2 - 11
3. OPERATION EXAMPLES	3 - 3
3.1 PURPOSE	3 - 3
3.2 SIMPLE OPERATION EXAMPLES	3 - 4
4. BASIC OPERATION FOR MEASUREMENT	4 - 3
4.1 OUTLINE	4 - 3
4.1.1 Menu Screens and Related Functions	4 - 3
4.2 MENU SCREEN OPERATIONS IN TIMING ANALYZER APPLICATIONS	4 - 6
4.2.1 Configuration of Input Channels in the Timing Analyzer (CONFIG menu)	4 - 6
4.2.2 Setting the Tracing Conditions in the Timing Analyzer (TRACE menu)	4 - 9
4.2.3 Acquired-data Scree in the Timing Analyzer (DISPLAY menu)	4 - 15
5. DISK FILE PROCESSING FUNCTIONS AND OPERATIONS	5 - 3
5.1 PRELIMINARY KNOWLEDGE FOR DISK FILE PROCESSING	5 - 3
5.1.1 Outline of Disk File Processing	5 - 3
5.1.2 Disk Handling Precautions	5 - 4
5.1.3 System Disks and Data Disks	5 - 6
5.1.4 Classification of Files	5 - 6
5.1.5 Starting and Erasing the Submenu Screen by the GET/SAVE/FD Functions	5 - 9
5.2 GET FUNCTIONS AND OPERATIONS	5 - 10
5.2.1 Ordinary GET Function and Operations	5 - 10
5.2.2 QuickGET Function and Operations	5 - 10
5.3 SAVE FUNCTIONS AND OPERATIONS	5 - 12
5.3.1 Ordinary SAVE Function and Operations	5 - 12
5.3.2 Quick SAVE Function and Operations	5 - 12

TR4726
LOGIC ANALYZER
OPERATION MANUAL

TABLE OF CONTENTS

TABLE OF CONTENTS (Cont'd)

5.4 DIRECTORY FUNCTIONS AND OPERATIONS	5 - 14
5.4.1 DIRECTORY-of-MENU Function and Operations	5 - 14
5.4.2 DIRECTORY-of-ALL Function and Operations	5 - 14
5.5 REGISTER FUNCTION AND OPERATIONS	5 - 15
5.6 PURGE FUNCTION AND OPERATIONS	5 - 16
5.7 DELETE FUNCTION AND OPERATIONS	5 - 18
5.8 FORMAT FUNCTION AND OPERATIONS	5 - 19
5.9 RENAME FUNCTION AND OPERATIONS	5 - 20
5.10 COPY FUNCTION AND OPERATIONS	5 - 21
5.11 STATUS FUNCTIONS AND OPERATIONS	5 - 23
5.11.1 STATUS-of-FILES Function and Operations	5 - 23
5.11.2 STATUS-of-DISK Function and Operations	5 - 23
6. PROGRAM PREPARATION AND EXECUTION (PROGRAM/AUTO)	6 - 3
7. SERIAL COMMUNICATIONS FUNCTIONS AND OPERATIONS (COMM)	7 - 3
7.1 OUTLINE	7 - 3
7.2 EXECUTION OF REMOTE CONTROL	7 - 4
7.3 REMOTE CONTROL PROTOCOLS	7 - 5
7.4 REMOTE CONTROL COMMANDS	7 - 9
8. UTILITY FUNCTION AND OPERATIONS	8 - 3
8.1 UTILITY COMMAND LOADING	8 - 3
8.2 CALENDAR CLOCK SETTING	8 - 4
8.3 COMMUNICATIONS (RS-232C) PARAMETER SETTING	8 - 5
8.4 SETTING THE DISK DRIVE	8 - 7
8.5 FLOPPY DISK FORMATTING AND INITIALIZATION	8 - 8
8.6 DISK COPY	8 - 10
9. PRINT FUNCTIONS AND OPERATIONS	9 - 1
9.1 PRINT FUNCTION	9 - 3
9.2 OPERATIONS	9 - 4
10. OPERATION CHECK AND ADJUSTMENT	10 - 3
10.1 SELF-DIAGNOSTIC FUNCTION	10 - 3
10.2 CRT ADJUSTMENT	10 - 4
11. STORAGE, CLEANING, AND TRANSPORTATION	11 - 3
11.1 STORING PRECAUTIONS ON TR4726	11 - 3
11.2 CLEANING THE CRT DISPLAY UNIT	11 - 4
11.3 TRANSPORTATION OF THE TR4726	11 - 5
12. PERFORMANCE SPECIFICATIONS	12 - 3
12.1 TR4726	12 - 3
12.2 PERFORMANCE SPECIFICATIONS OF OPT4726+75 (300 MHz TIMING MODULE)	12 - 7
12.3 PERFORMANCE SPECIFICATIONS OF OPT4726+70 (100 MHz TIMING MODULE)	12 - 9
12.4 PERFORMANCE SPECIFICATIONS OF THE STATE ANALYZER	12 - 11

TR4726
LOGIC ANALYZER
OPERATION MANUAL

TABLE OF CONTENTS

TABLE OF CONTENTS (Cont'd)

12.5 I/O INTERFACE SPECIFICATIONS	12 - 12
12.5.1 RS-232C Interface Specifications	12 - 12
12.5.2 Video Signal Interface	12 - 12
12.5.3 State Analyzer Trigger Pulse Output	12 - 14
12.5.4 Timing Analyzer Trigger Pulse Output	12 - 14
13. OPERATIONAL DESCRIPTION	13 - 3
13.1 OVERVIEW	13 - 3
13.2 OPERATIONAL DESCRIPTION OF EACH BLOCK	13 - 5
13.2.1 Main Facility	13 - 5
13.2.2 Optional Facility	13 - 5

TR4726
LOGIC ANALYZER
OPERATION MANUAL

1. INTRODUCTION

TABLE OF CONTENTS

1. INTRODUCTION	1 - 3
1.1 HOW TO USE THIS MANUAL	1 - 3
1.2 PRODUCT DESCRIPTION	1 - 4
1.3 BEFORE STARTING UP THE ANALYZER	1 - 5
1.3.1 Appearance Check and Attachments Check	1 - 5
1.3.2 Operating/environmental conditions and operating precautions	1 - 6
1.3.3 Connecting the power supply	1 - 7

TR4726
LOGIC ANALYZER
OPERATION MANUAL

1.1 HOW TO USE THIS MANUAL

1. INTRODUCTION

1.1 HOW TO USE THIS MANUAL

The TR4726 logic analyzer consists of the TR4726 main unit, a timing analysis module (optional), and a synchronous analysis module (optional).

The TR4726 can be combined with the above two optional units and a dedicated personality kit (also optional), to be configured in the following three ways:

- (1) Timing analyzer
This configuration combines the TR4726 and an optional timing module.
- (2) State analyzer
This configuration combines the TR4726, a synchronous analysis module (optional), and a dedicated personality kit.
- (3) S & T (State and Timing) analyzer
This configuration combines both (1) and (2) above.

This operation manual describes the TR4726 operations as a timing analyzer and as a state analyzer.

The operational details of each type of dedicated personality kit available are given in their respective operational manuals.

TR4726
LOGIC ANALYZER
OPERATION MANUAL

1.2 PRODUCT DESCRIPTION

1.2 PRODUCT DESCRIPTION

The TR4726 is a logic analyzer that debugs a entire digital system (usually, a microprocessor-applied system) by simultaneously analyzing the hardware and software operations of the system. The following gives an overview of this product.

- (1) S & T facility: One TR4726 can incorporate both a "logic/state analyzer facility" (software analyzer), which analyzes the microprocessor, and a "logic/timing analyzer facility" (hardware analyzer), which analyzes the peripheral circuitry. These two facilities can be operated independently of each other, and in addition, both permit their respective triggers to be armored. Thus, all operational aspects of the entire digital system can be analyzed with one TR4726.
- (2) New user interfaces: The TR4726 uses various new user interfaces such as the 3.5-inch floppy disk drive (1 MB, unformatted), the 5 x 9-inch CRT (80 x 24 characters), and the scroll knob. These interfaces combined provide operational sophistication with reduced burden on the user.
- (3) State analyzer using the personality kit method: The input portion of the state analyzer of the TR4726 uses the personality kit plug-in method. The input portion can be easily replaced with the desired type. Analysis can then be made always under the best operating conditions by using the personality kit best suited for the system that is to be analyzed. In addition, using high-flexibility tracing control (tracing/windowing conditions), mnemonic codes, special symbols, etc. allow efficient debugging.

TR4726
LOGIC ANALYZER
OPERATION MANUAL

1.3 BEFORE STARTING UP THE LOGIC ANALYZER

1.3 BEFORE STARTING UP THE ANALYZER

1.3.1 Appearance Check and Attachments Check

After receiving the TR4726, first check to see if it has been accidentally damaged during transportation. Next, check the quantity and specifications of each of the standard attachments listed in the tables below. Either the ADVANTEST CE headquarters (Yokohama, Japan) or the ADVANTEST distributor nearest to you should be contacted if the instrument or an attachment has become damaged or if there are missing parts. The addresses and telephone numbers of the ADVANTEST CE headquarters and distributors will be listed at the end of this manual.

(1) Standard attachments to the TR4726

Item	Model	Q'ty	Remarks
Power cable	MP-43A	1	
Operation manual	J4726	1	

(2) Standard attachments to the OPT4726+75 (optional)

Item	Model	Q'ty	Remarks
High-speed data acquisition probe E	TR14705-01	1	
High-speed data acquisition probe F	TR14705-02	1	
System software package	P4726-7075FJ	1	
Blank disk		1	
Disk storage case		1	
Case for miscellaneous items		1	

TR4726
LOGIC ANALYZER
OPERATION MANUAL

1.3 BEFORE STARTING UP THE LOGIC ANALYZER

- (3) Standard attachments for the OPT4726+70 (optional)

Item	Model	Q'ty	Remarks
Data acquisition probe E	TR14702-01	1	
Data acquisition probe F	TR14702-02	1	
System software package	P4726-7075FJ	1	
Blank disk		1	
Disk storage case		1	
Case for miscellaneous items		1	

1.3.2 Operating/environmental conditions and operating precautions

- (1) Do not operate the instrument in dusty places, in direct sunlight, or in the presence of corrosive gases. Always operate it in ambient temperatures of +5 to +40 degrees C and relative humidities of 20 to 80 percent (non-condensing).

- (2) This instrument draws in cool air from the upper section of the front panel and from the rear section of the right side, and blows it out through the fans and connector slots on the rear panel.

Install the logic analyzer in an area that will allow normal ventilation. In addition, keep the top of the logic analyzer clean and free of objects.

- (3) This logic analyzer is sufficiently designed to cope with noise induced from the AC power line. However, operate it in an environment as noiseless as possible to ensure continued normal operation. Use a noise reduction filter, etc. if there is much noise interference.
- (4) Do not use the logic analyzer in places highly prone to vibrations.
- (5) In order to protect the built-in floppy disk drive, always operate the logic analyzer with its front panel facing sideways. (Operate the logic analyzer at angles within ± 30 degrees with respect to the horizontal direction.)

TR4726
LOGIC ANALYZER
OPERATION MANUAL

1.3 BEFORE STARTING UP THE LOGIC ANALYZER

- (6) Although the CRT display is preadjusted at the factory to give minimum screen distortion, the screen may become noticeably distorted because of the effects of external magnetic fields, geomagnetism, etc.

1.3.3 Connecting the power supply

- (1) Connecting the logic analyzer with the power cable
First check that the POWER switch on the front panel is OFF. Then connect the power cable (supplied) to the AC LINE connector on the rear panel.

The operating supply voltage is set to the user specifications at the factory. The logic analyzer operates in the standard 90 to 132 VAC range (unless otherwise specified) or in the 180 to 249 VAC range (where option 40 is specified). In either case, the power frequency must be 50 or 60 Hz.

- (2) Use of adaptor A09034 (supplied)
The plug of the power cable has three prongs, of which the middle one (round-shaped) is the grounding prong.

Connect the adaptor to the plug, plug it into an electrical outlet and ground the logic analyzer by connecting either the adaptor's grounding wire [Figure 1-1 (a)] to a ground or the grounding terminal located on the rear panel of the logic analyzer to a ground.

The adaptor A09034 (supplied) conforms to the Japanese electrical supplies control law. The two electrodes of this adaptor differ in width (A and B), as shown in Figure 1-1 (b). Before plugging in the adaptor to an electrical outlet, make sure that the adaptor fits the actual outlet. An optional adaptor KPR-13 is available in case the adaptor does not fit.

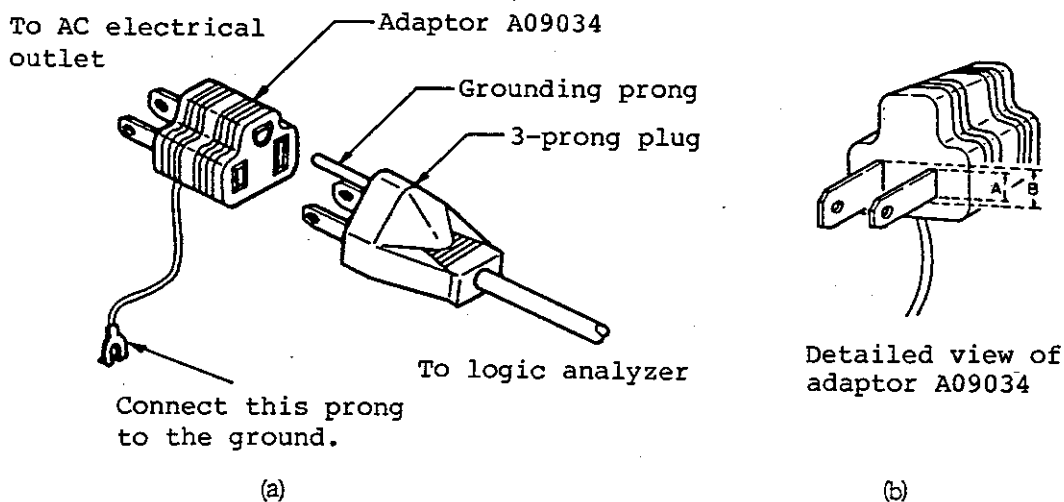

Figure 1-1 Power Cable Plug and Adaptor

TR4726
LOGIC ANALYZER
OPERATION MANUAL

1.3 BEFORE STARTING UP THE LOGIC ANALYZER

- (3) This logic analyzer is fitted with circuit breakers
For safety reasons, do not use the breakers as a power switch.

Before plugging the power cable into an electrical outlet, be sure to check that the POWER switch is OFF.

TR4726
LOGIC ANALYZER
OPERATION MANUAL

2. ANALYSIS PREPARATIONS AND PRELIMINARY KNOWLEDGE

TABLE OF CONTENTS

2. ANALYSIS PREPARATIONS AND PRELIMINARY KNOWLEDGE	2 - 3
2.1 PURPOSE	2 - 3
2.2 SETTING UP THE LOGIC ANALYZER	2 - 4
2.3 DETAILED PROCEDURE FOR CONNECTING DATA ACQUISITION PROBES E AND F	2 - 5
2.4 SYSTEM SOFTWARE LOADING PROCEDURE	2 - 8
2.5 DATA INPUT METHODS FOR EACH MENU ITEM	2 - 9
2.6 PANEL DESCRIPTION	2 - 11

TR4726
LOGIC ANALYZER
OPERATION MANUAL

2.1 PURPOSE

2. ANALYSIS PREPARATIONS AND PRELIMINARY KNOWLEDGE

2.1 PURPOSE

Read throughly the contents of this section before operating the logic analyzer for the first time. This section describes the preparations to be made for analysis and the preliminary knowledge required for operation of the logic analyzer. This section is organized so that the user can easily understand the contents simply by carrying out the preparatory procedures and instrument operations as shown in this section. It is recommended, therefore, that this section be always read with the logic analyzer on hand.

TR4726
LOGIC ANALYZER
OPERATION MANUAL

2.2 SETTING UP THE LOGIC ANALYZER

2.2 SETTING UP THE LOGIC ANALYZER

The operation of the logic analyzer requires the connecting of the data acquisition probes (for timing analysis) and the microprocessor probes (for state analysis).

(1) Connecting the data acquisition probes

Two types of data acquisition probes are provided E and F.

Insert probe E into the slot on the E-side of the rear panel, and probe F, into the slot on the F-side of the rear panel.

(2) Connecting the microprocessor probes

Insert the dedicated microprocessor probes, A to D, into slots A to D of the rear panel.

Refer to the PK operation manual for further details.

NOTE

Before connecting the above probes, check that the logic analyzer is turned off.

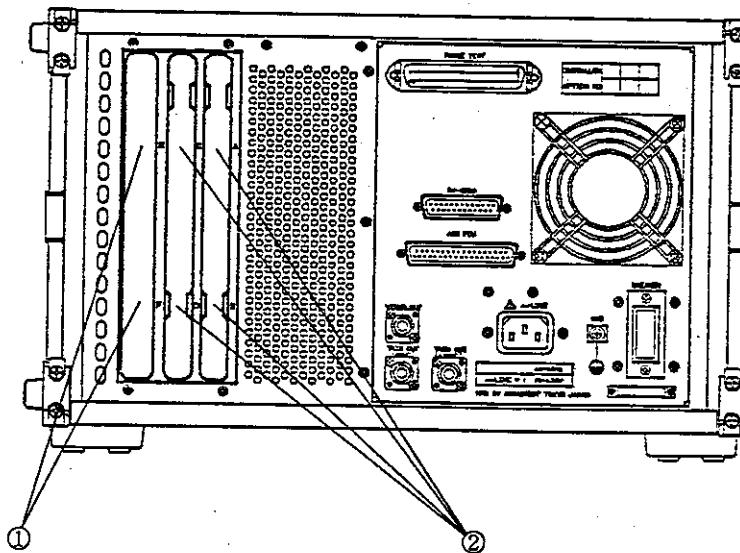

Slots for the acquisition probes Slots for the microprocessor probes

Figure 2-1 Connection of Probes

TR4726
 LOGIC ANALYZER
 OPERATION MANUAL

2.3 DETAILED PROCEDURE FOR CONNECTING DATA ACQUISITION PROBES E AND F

2.3 DETAILED PROCEDURE FOR CONNECTING DATA ACQUISITION PROBES E AND F

To fetch signals from the system under test (hereinafter referred to as the SUT), data acquisition probes E and F must be used. Each of these two probes allows signals to be fetched for every eight channels.

The configurations and component part names of the probes are shown in Figure 2-2 and Figure 2-3.

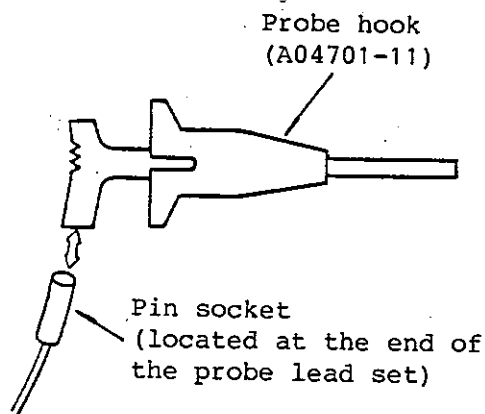
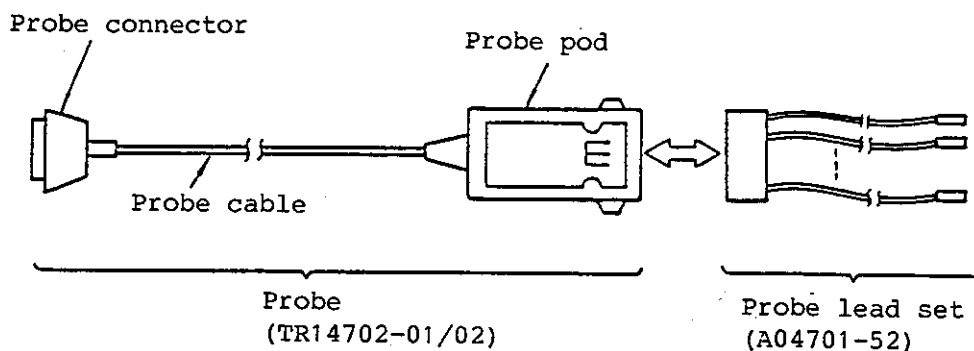

The double arrow \Leftrightarrow indicates that this particular section can be disconnected.

Figure 2-2 Probes E and F Configurations and Their Component Part Names (OPT4726+70)

TR4726
LOGIC ANALYZER
OPERATION MANUAL

2.3 DETAILED PROCEDURE FOR CONNECTING DATA ACQUISITION PROBES E AND F

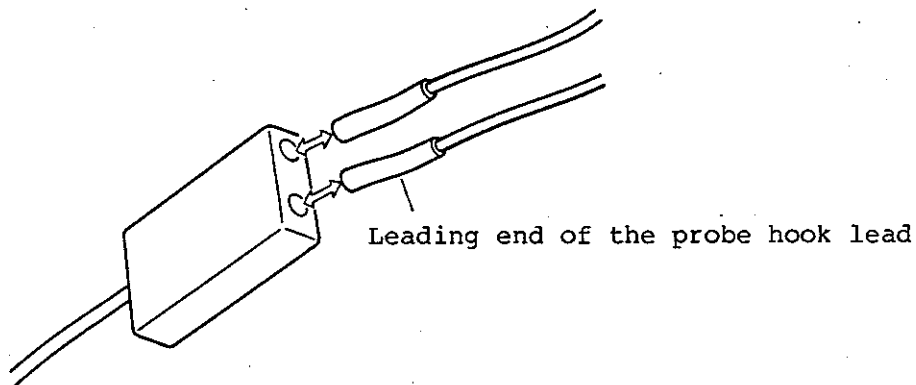
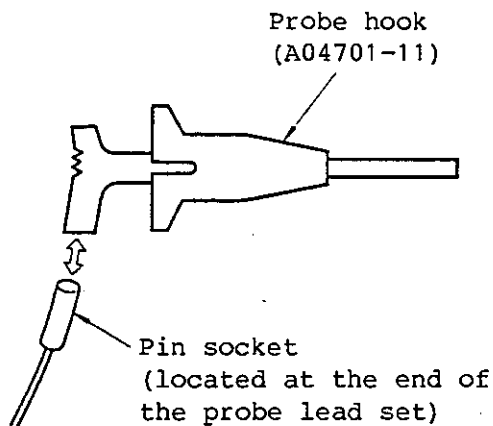
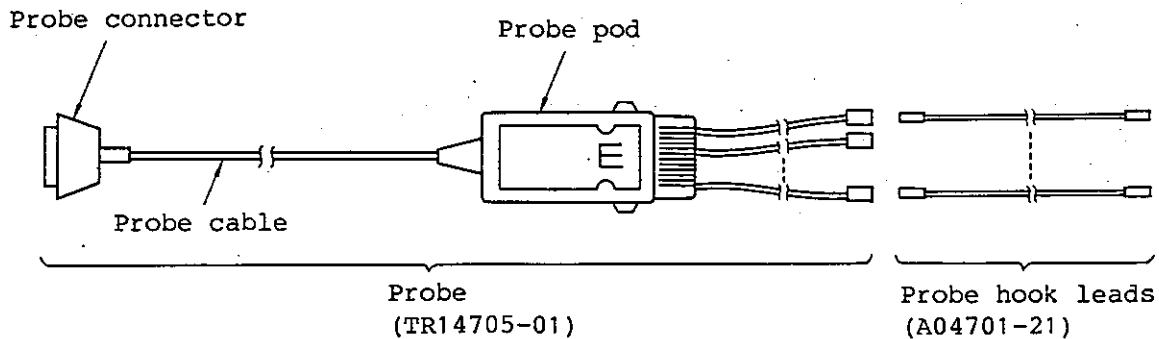

The double arrow \leftrightarrow indicates that this particular section can be disconnected.

Figure 2-3 Probes E and F Configurations and Their Component Part Names (OPT4726+75)

TR4726
LOGIC ANALYZER
OPERATION MANUAL

2.3 DETAILED PROCEDURE FOR CONNECTING DATA ACQUISITION PROBES E AND F

Next, connect the acquisition probes and the SUT.

Generally, to connect the acquisition probes with the SUT use either the pin-socket fitted probe lead set (A04701-52) or the probe hook leads (A04701-21) and the probe hook (A04701-11). If the particular SUT has pins that match the pin sockets, however, the probes can be connected directly to those pin sockets. The model name and size of the pin sockets are as follows:

Manufacturer	Model	Size applicable
AUGAT	LSG-2BG2-1	0.51 mm ϕ - 0.76 mm ϕ

Optional accessories may be used, as appropriate, to connect the probes to the SUT. Consult the catalog that lists the accessories/supplies available with the logic analyzer.

2.4 SYSTEM SOFTWARE LOADING PROCEDURE

2.4 SYSTEM SOFTWARE LOADING PROCEDURE

A large portion of the system software, which controls the operations of the instrument, is run after having been loaded from the system disk P4726-7075FJ into the internal memory of the logic analyzer. To load the system software use the built-in floppy disk drive.

Insert the system disk into the floppy disk drive and then set the POWER switch to the ON position. Loading will automatically begin.

Loading will take approximately one minute to complete. After loading is completed, a CONFIGURATION menu display such as that shown in Figure 2-4 will appear to indicate that the system is ready for operation.

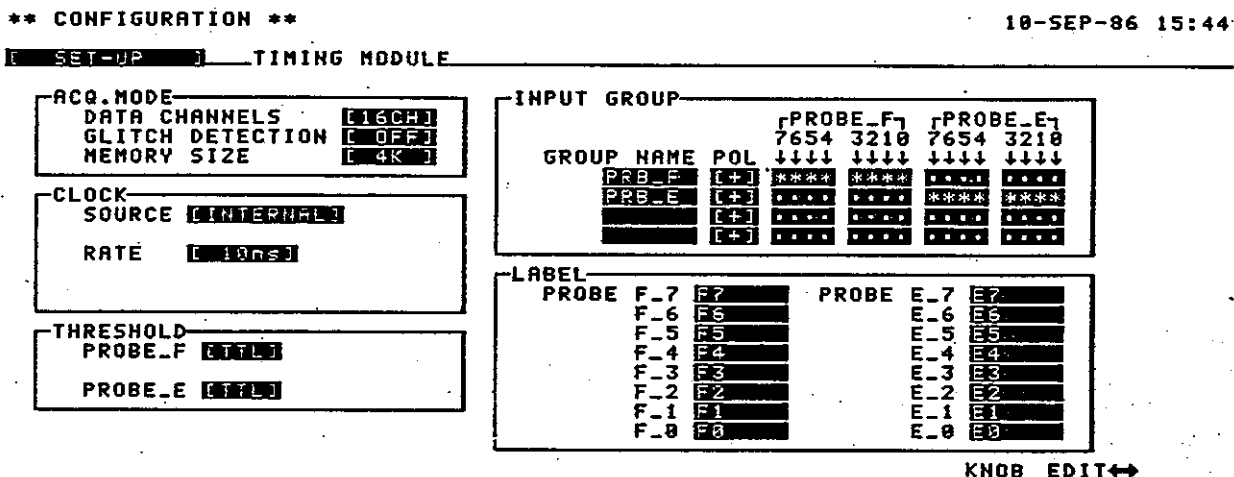

Figure 2-4 Display at the End of Loading (CONFIG Menu Display)

If the system disk has not been inserted into the floppy disk drive after powering on, a prompt will be displayed requesting insertion of the system disk.

2.5 DATA INPUT METHODS FOR EACH MENU ITEM

2.5 DATA INPUT METHODS FOR EACH MENU ITEM

Pressing the keys of the MENU key group and I/O key group causes corresponding menu screens to appear for each key.

One menu screen contains more than one menu item.

The menu screen that corresponds to the key of the MENU key group is referred to as the main menu screen.

The menu screen that corresponds to the key of the I/O key group is referred to as the sub menu screen. A sub menu screen can be called up at any time to overlap the main menu screen, and can also be erased at any time. (To erase the screen press either the key of the MENU key group or the STOP key.) When a sub menu screen appears, the main menu screen will appear in half-tone. Press a key from each corresponding key group to make sure that these events actually occur.

The basic rules related to data input for each menu item are very simple. they are listed below:

- . Menu items for which data can be input are always displayed in highlighted form.
- . The menu item currently being prompted to request the operator to input data using the ENTRY key group, is always blinking in highlighted form.
- . The input prompt can be moved using only the ← → ↑ ↓ keys.
- . Selection between menu items in brackets ([]) can only be made using the SELECT keys.

As the above basic rules imply, there are two methods by which data can be input for menu items:

- (1) Menu items enclosed in []
Data input for menu items enclosed in [] can be carried out by pressing the SELECT (NEXT, PREV) keys to select from data groups displayed in chain form.

Use the NEXT and PREV keys to select data circularly in forward and reverse directions, respectively.

Note, however, that selectable data groups may vary according to the particular ambient conditions even for the same item.

Those parenthesized menu items that are not highlighted do not permit data input since such item consists of only one parameter.

In the case of the menu display made using the DISPLAY key, all menu items use this method, except for [TIMING].

Press the NEXT key several times to check what kind of parameters form each data group in menu items (such as [x1], [16CH], CURSOR column, KNOB column, etc.) and also check how the display changes.

TR4726
LOGIC ANALYZER
OPERATION MANUAL

2.5 DATA INPUT METHODS FOR EACH MENU ITEM

- (2) Menu items not enclosed in []
For menu items that are not enclosed in [], data must be input using the ENTRY key group except the SELECT keys.

Such menu items can be divided into two types. The first type requires defining GROUP names, SYMBOL names, CODE names, and LABEL names (of these, the first three are available only for the state analyzer) and using the file names. The second type requires using binary, octal, decimal, and hexadecimal numbers.

When moving the input prompt using the keys, the first character (or digit) in each menu item will become an input prompt.

In the timing analyzer, this input method uses LABEL names, for example.

 CONFIG
Pressing the key causes the CONFIGURATION menu to be displayed. For this menu, any desired LABEL name can be input (in six characters or less) for the LABEL name menu item. After LABEL name input, press

 DISPLAY
the key. This will cause the input LABEL name to appear, as the corresponding channel signal name, on the CONFIGURATION menu display.

2.6 PANEL DESCRIPTION

This section briefly describes the front and rear panels of the logic analyzer. This section does not need be thoroughly read if the user operates the instrument for the first time. Reference should be made to Figures 2-5 and 2-6, instead.

- Front panel -

①

MENU key group

The main menu display can be called by pressing a key of this key group. Pressing a key of this key group during analysis terminates analytical processing and displays the appropriate menu screen.

Pressing a key of this key group during an I/O operation saves the I/O data and displays the appropriate menu screen.

The CONFIG menu screen is automatically displayed immediately after loading of the system software.

STATE

TIMING key: Used to select between the state analyzer and the timing analyzer.

STATE
TIMING

TRACE key: Used to call the TRACE menu. While this menu remains on the screen, various tracing parameters can be set.

TRACE

DISPLAY key: Used to call the DISPLAY menu. On this menu, analytical data can be displayed in various formats.

DISPLAY

CONFIG key: Used to call the CONFIG menu. Input channels for the logic analyzer can be configured on this menu. For the state analyzer, input channel names can be defined by grouping those input channels.

CONFIG

SYMDEF key: Used to call the SYMDEF menu. Symbols and codes can be defined for each input GROUP while this menu remains on the screen.

SYM DEF

PROGRAM key: Used to call the PROGRAM menu. This menu allows preparation of command files that contains analytical and other sequences.

PROGRAM

UTILITY key: Used to call the UTILITY menu. This menu allows internal calendar clock setting, etc.

UTILILTY

② EDIT key group

These keys enable editing to be done on the menu items being displayed on a menu screen.

keys: Used for downward or upward movement of the input prompt being displayed for a menu item.

keys: Used for leftward or rightward movement of the input prompt being displayed for a menu item.

(HOME) key: Used to move the input prompt to home position on each menu screen.



INSERT, DELETE keys: Used to insert or delete data in lines on the SYMDEF or PROGRAM menu.

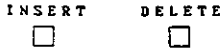

DEFAULT key: Used to revert the system from a particular menu screen to the initial screen display.



③ ENTRY key group

Data can be input for each menu item using this key group. Data can be input using only the SELECT key group.

Letters can also be input if the ENTRY key group is used with the SHIFT key. While the internal LED of the SHIFT key remains lit, it is possible to input the character inscribed in blue on the upper section of each key.

NEXT, PREV keys: Used to call up data groups that succeed or precede the one currently being displayed. These keys can be used only for menu items that are enclosed in []. Pressing and keys change data in forward and reverse directions, respectively.



"0" to "9" keys: Used to input binary, octal, decimal, and "A" to "F" keys hexadecimal numerals.

"A" to "Z" keys: Used to input letters.

SP key: Used to input null characters (blank spaces). In names defined using the TR4726, blank spaces are handled in a similar manner as that of ordinary characters.

." key: Used to input the symbol "." (period). When used with a file name, "." acts as a delimiter that separates the name and the extender.

TR4726
LOGIC ANALYZER
OPERATION MANUAL

2.6 PANEL DESCRIPTION

X (DON'T CARE) key: Used to input a Don't Care number that allows a binary, octal, or hexadecimal digit to be regarded as equivalent to a given value.

+/- key: Used to invert a menu item value from positive to negative, or vice versa, if that item value can be inverted.

↑, ↓ keys: Used to select edge trigger inputs during TRACE operations.

④ EXECUTE key group

Analysis can be started or stopped using this key group.

RUN key: Used to start the execution of analysis under the conditions that have been set on the TRACE menu.

RUN

AUTO key: Used to start the execution of analysis in accordance with the command file sequence that has been set on the PROGRAM menu.

AUTO

STOP key: Used to interrupt the ongoing analysis at the desired time. Also used to recall the original sub menu from the help screen.

STOP

⑤ SCROLL key group

The menu screen can be scrolled up/down or to the left/right using this key group.

Scroll control: Turning this control scrolls screen up/down (or to the left/right) at the desired speed.

PAGE key: Used to scroll the screen page by page.

⑥ I/O key group

With this key group, sub menu screens for input/output device operations can be displayed and then modified.

When a sub menu screen is displayed, the main menu screen will assume a half-tone display and thus data input will become temporarily impossible.

FD key: Used when operating the internal and/or external 3.5-inch micro floppy disk drives.

FD

There are eight functions available with this key:

DIRECTORY, REGISTER, PURGE, DELETE, FORMAT, RENAME, COPY, and STATUS.

TR4726
LOGIC ANALYZER
OPERATION MANUAL

2.6 PANEL DESCRIPTION

These functions can be used on all main menu screens, except the UTILITY menu screen.

Pressing this key when the data can be input on a particular main menu screen displays the corresponding sub menu. The main menu screen displays in half-tone to indicate that subsequent data input can be done only for the menu items of the sub menu screen.

Pressing this key again allows the execution of the commands on the sub menu screen.

GET key: Used to read out the files on a floppy disk and to display the contents of those files on the main menu screen.

GET

This key also serves as an EXECUTE key. The Quick Get function, which can be executed simply by pressing this key twice, is available for specific files (registered files).

SAVE key: Used to write main menu data into a file on a floppy disk.

SAVE

This key also serves as an EXECUTE key. The Quick Save function, which can be executed simply by pressing this key twice, is available for specific files (system-saved files).

COMM key: Used to communicate with external computers or terminal devices.

COMM

This key also acts an EXECUTE key.

⑦ HELP key: This key can be used to obtain detailed information on menu items. It is available at any time, except during analysis or during input/output operations.

HELP

⑧ (KNOB) key: This key performs various functions such as the SELECT function of the ENTRY key group, the prompt-movement function of the EDIT key group, the data scroll function, etc. The function that the key performs at the particular time depends on the type of screen displayed.

□

⑨ 3.5-inch micro floppy disk drive
This micro floppy disk drive can be used as an auxiliary memory for the TR4726. The memory capacity is 1 MB for unformatted, double-sided/double-density disks, and 632.5 KB for formatted, new disks. (1 KB = 1024 B)

Additionally, the micro floppy disk is used to load the system software when powered on.

TR4726
LOGIC ANALYZER
OPERATION MANUAL

2.6 PANEL DESCRIPTION

- ⑩ POWER switch
This switch is used to supply AC power to the entire TR4726. When this switch is set to the ON position, the self-diagnostic function will activate to enable the TR4726 to be checked for normal operation.

When the switch is set to the OFF position, the AC power supply will be cut off immediately.

- ⑪ KEYBOARD connector
This connector is used to connect the ASCII keyboard (supplied together with the TR4726) to the TR4726.

The power for the keyboard is also supplied via this connector.

- Rear panel -

- ⑫ RS-232C connector
This connector is used for real-time communication with external computers or terminal devices. The signals conform to the RS-232C standard.

- ⑬ AUX FDU connector
This connector is used to connect the 3.5-inch micro floppy disk drive (supplied together with the TR4726) to the TR4726.

- ⑭ PROBE TEST connector
This connector is used to test general-purpose probes or microprocessor probes. Testing requires the use of a probe test adaptor that fits the particular probe used.

- ⑮ VIDEO OUT connector
This connector is used to connect a video plotter or a video display unit to the TR4726. The signal levels conform to the RS-232C standard.

- ⑯ TRIG OUT (SYNC) connector
This connector is used to output trigger pulses from an optional state analyzer.
With this connector, it becomes possible to output trigger pulses to an external logic analyzer, an oscilloscope, etc.

- ⑰ TRIG OUT (ASYNC) connector
This connector is used to output trigger pulses from an optional timing analyzer.
With this connector, it becomes possible to output trigger pulses to an external logic analyzer, an oscilloscope, etc.

- ⑱ Probe slot A
Used to connect a general-purpose probe or a micro-processor probe to the TR4726.

TR4726
LOGIC ANALYZER
OPERATION MANUAL

2.6 PANEL DESCRIPTION

- ①9 Probe slot B
Used to connect a general-purpose probe or a micro-processor probe to the TR4726.
- ②0 Probe slot C
Used to connect a general-purpose probe or a micro-processor probe to the TR4726.
- ②1 Probe slot D
Used to connect a general-purpose probe or a micro-processor probe to the TR4726.
- ②2 Probe slot E
Used to connect data acquisition probe E to the TR4726 when the optional timing analyzer is to be used.
- ②3 Probe slot F
Used to connect data acquisition probe F to the TR4726 when the optional timing analyzer is to be used.
- ②4 Circuit breaker
A circuit breaker is mounted within the TR4726 to protect the instrument from an overcurrent, a power surge, etc.

For safety reasons, do not use this breaker as a electrical on/off switch.
- ②5 Power cable connector
Before connecting the power cable, ensure that the power switch on the instrument is placed in the OFF position.
- ②6 GND terminal
This is a grounding terminal. When a 2-pin adaptor is to be attached to the power cable, either the wire leading from the adaptor or the GND terminal must be connected to ground.

2.6 PANEL DESCRIPTION

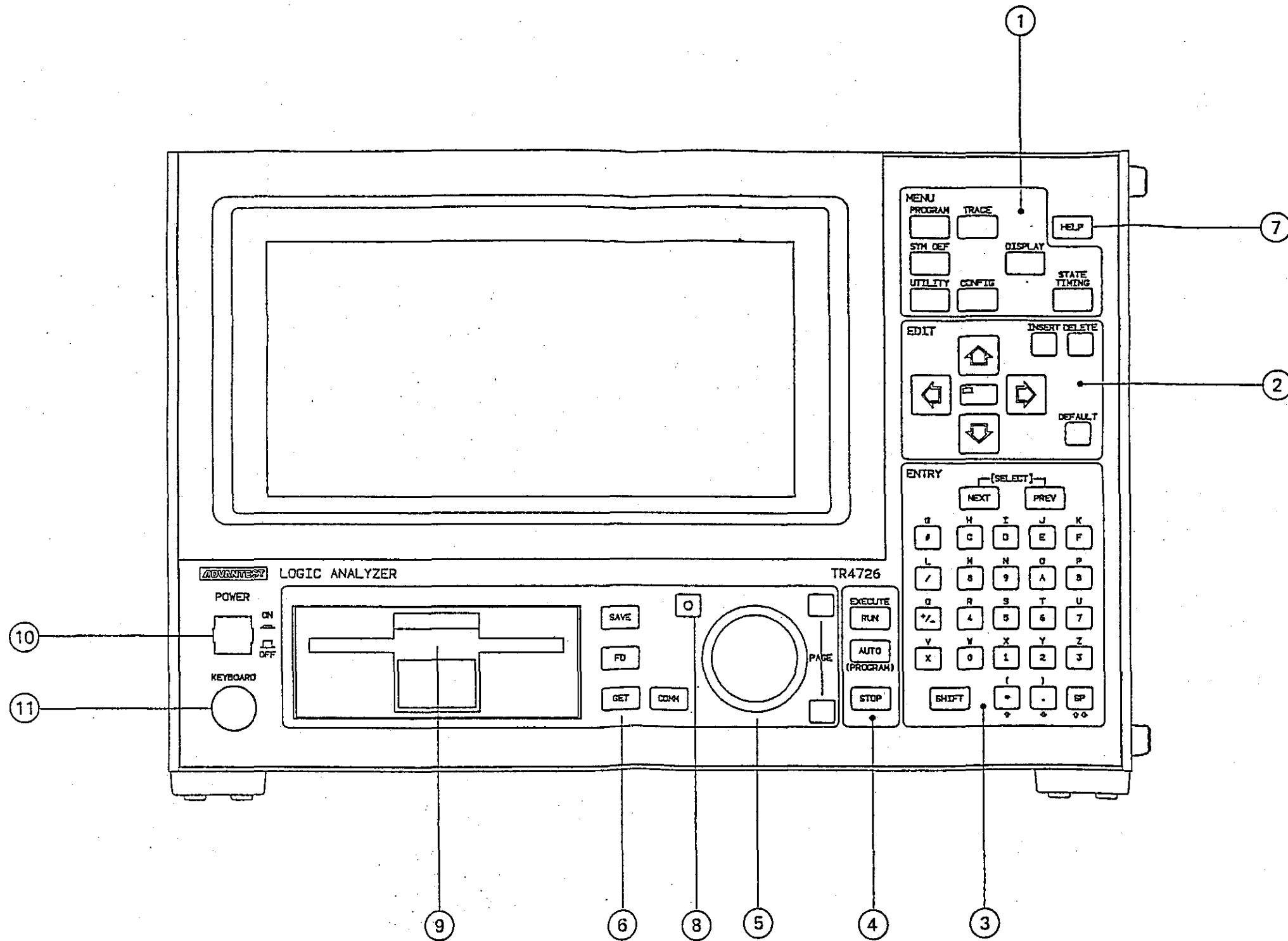

Figure 2-5 Front Panel

2.6 PANEL DESCRIPTION

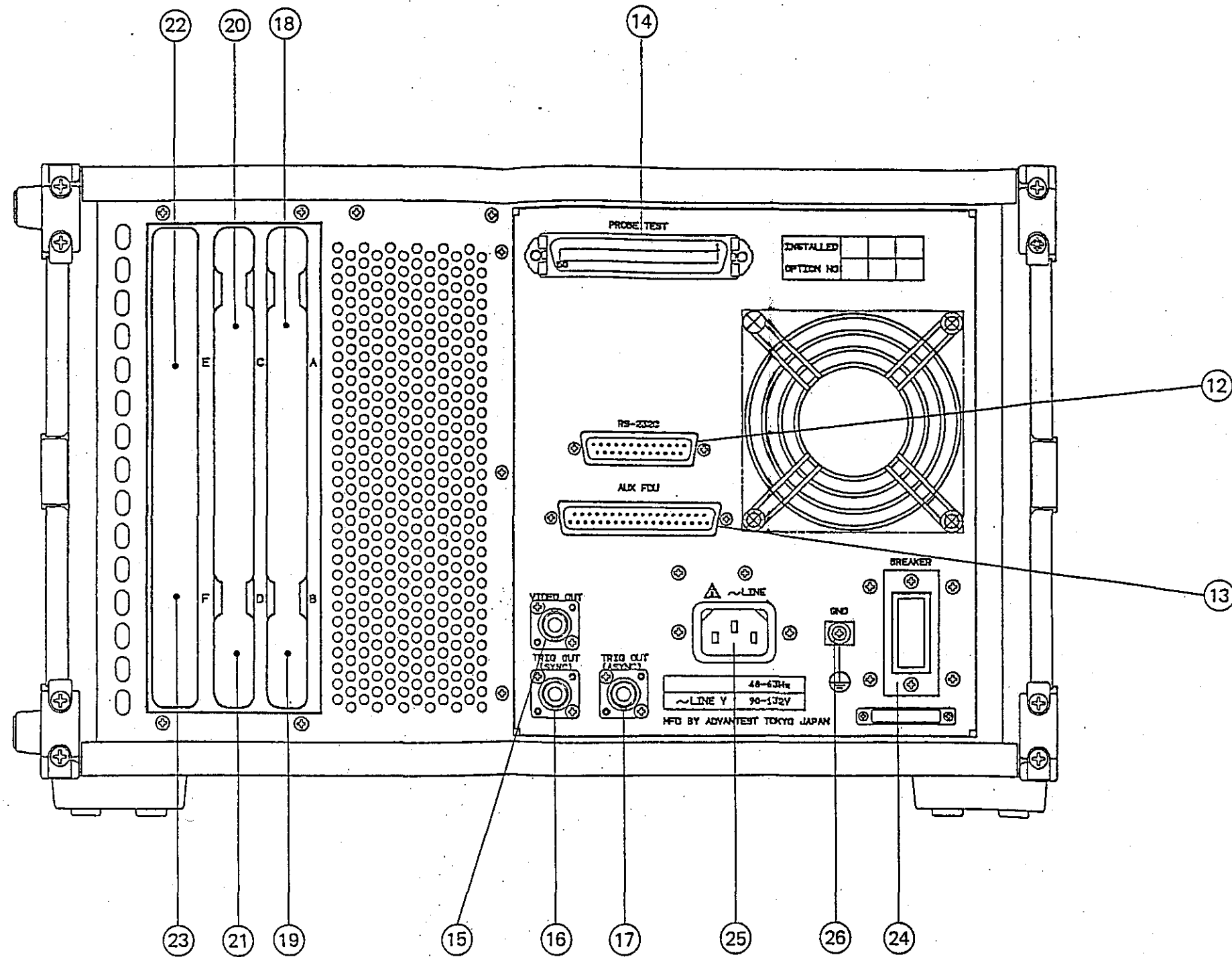

Figure 2-6 Rear Panel

TR4726
LOGIC ANALYZER
OPERATION MANUAL

3. OPERATION EXAMPLES

TABLE OF CONTENTS

3. OPERATION EXAMPLES	3 - 3
3.1 PURPOSE	3 - 3
3.2 SIMPLE OPERATION EXAMPLES	3 - 4

TR4726
LOGIC ANALYZER
OPERATION MANUAL

3.1 PURPOSE

3. OPERATION EXAMPLES

3.1 PURPOSE

This section is intended to enable first-time users to learn thoroughly and quickly how to operate the timing analyzer.

3.2 SIMPLE OPERATION EXAMPLES

First, connect the probe E/F to the timing analyzer (for detailed procedures, see sections 2.2 and 2.3) and then load the system software (see section 2.4).

The TR4726's initial menu screen consists of "*** CONFIGURATION ***", "*** TRACE SPECIFICATION ***", and "*** DISPLAY ***". Of these, only "*** CONFIGURATION ***" will remain on the screen when the system software has been loaded. The initial screen of "*** CONFIGURATION ***" will display as shown in Figure 3-1.

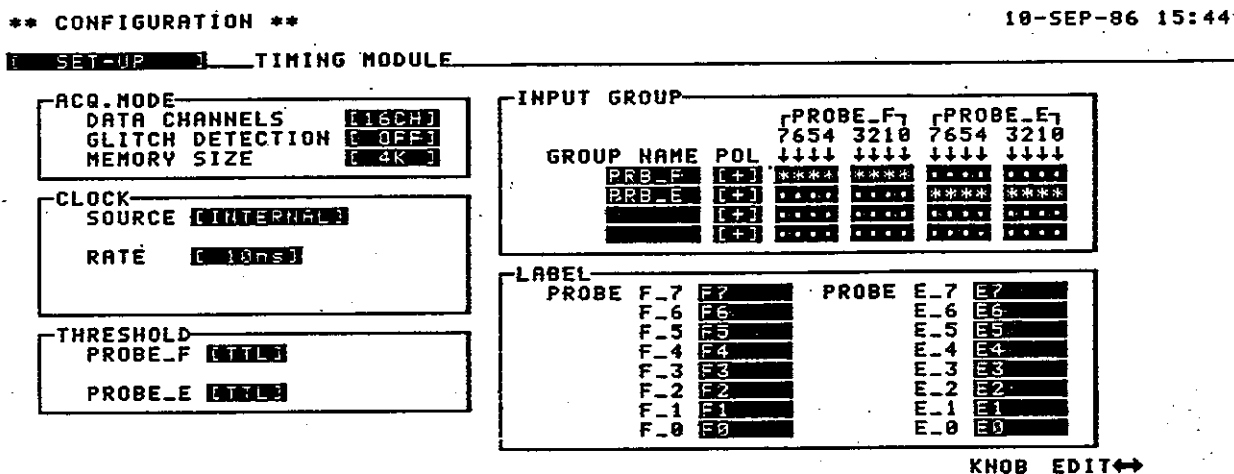

Figure 3-1 Initial Screen of CONFIGURATION

The data storage capacity, input-data fetch conditions, etc. are to be set on this screen. The initial screen will contain the following data items:

- . DATA CHANNELS 16CH Input data is to be fetched via the 16 channels of PROBE E or PROBE F.
- . MEMORY SITE 4K Four k's of data are acquired per channel.
- . -CLOCK- SOURCE INTERNAL ... The sampling clock source is an internal one, with a sampling clock rate of 10 ns.
 RATE 10ns
- . -THRESHOLD- TTL The input-data fetching level is preset to the TTL level.
- . -LABEL- PROBE_E and PROBE_F are used as the input-channel labels.

TR4726
LOGIC ANALYZER
OPERATION MANUAL

3.2 SIMPLE OPERATION EXAMPLES

Next, press the TRACE key ().

The menu screen will change into:

```

** TRACE SPECIFICATION **                                     11-SEP-86 21:44
TRACE TIMING_____TRIG.MODE [SEQUENTIAL]_____QuickVIEW [OFF]
GROUP      [PRB_F ] [PRB_E ] [      ] [      ]
RADIX      [BIN  ] [BIN  ] [BIN  ] [BIN  ]
[FILTER]
ENBL_1     01  [XXXXXXXX] [XXXXXXXX]
ENBL_2     01  [XXXXXXXX] [XXXXXXXX]
ENBL_3     01  [XXXXXXXX] [XXXXXXXX]
TRIG [ 1 ] 01  P[XXXXXXXX] [XXXXXXXX]
           G[*****] [*****]
DSBL       01  [XXXXXXXX] [XXXXXXXX]
TRIG.EVENT [  ] 00001 TIMES
TRIG.POSITION [BEGIN] (DELAY: -00100)
CLOCK RATE  [ 10ns]
    
```

KNOB EDIT↔

Figure 3-2 TRACE Menu Screen

The trigger conditions (the conditions for fetching the input data) are to be set on this screen.

The initial screen of the TRACE menu will contain the data listed below.

MODE:

Triggering uses either the SEQUENTIAL or the SERIAL mode, but the former is selected for the initial menu automatically.

The sequential mode refers to the mode in which input patterns occur in normal ascending order of pattern number (EBL1 to EBL3) and then data fetch begins upon the occurrence of a TRIG pattern(s).

For the initial screen of this menu, each of the patterns set will be "X" (Don't Care).

This indicates that EBL1 to EBL3 and TRIG can be recognized in any desired pattern.

In this case, therefore, the input pattern that appears first will be recognized as EBL1.

DSBL:

Disable function. This is a function used to reset the trigger recognition sequence. On the initial screen of this menu, this function appears as "X" to indicate that the function cannot be used.

TR4726
LOGIC ANALYZER
OPERATION MANUAL

3.2 SIMPLE OPERATION EXAMPLES

. TRIG EVENT:

The trigger event counter will display "00001". This indicates that data fetch begins upon the occurrence of a trigger pattern.

. TRIG POSITION:

The trigger delay setting will be [BEGIN]. This indicates that data fetch begins with each occurrence of a trigger pattern. This setting can be changed between "+" and "-". In the case of the "-" sign, it also becomes possible to fetch data existing before the occurrence of a trigger pattern.

Next, press the DISPLAY key ().

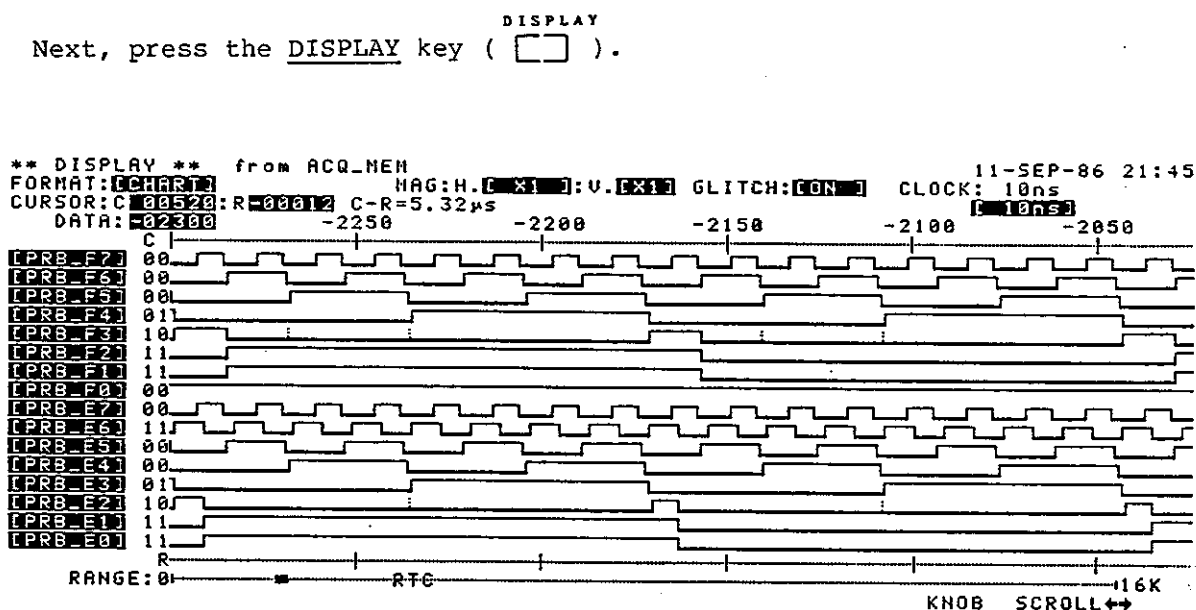

Figure 3-3 DISPLAY Menu Screen

This screen, which appears on the CRT, contains acquired data in a format suitable for analysis.

After execution of RUN, this screen will reappear automatically.

TR4726
LOGIC ANALYZER
OPERATION MANUAL

4. BASIC OPERATION FOR MEASUREMENT

TABLE OF CONTENTS

4. BASIC OPERATION FOR MEASUREMENT	4 - 3
4.1 OUTLINE	4 - 3
4.1.1 Menu Screens and Related Functions	4 - 3
4.2 MENU SCREEN OPERATIONS IN TIMING ANALYZER APPLICATIONS	4 - 6
4.2.1 Configuration of Input Channels in the Timing Analyzer (<u>CONFIG</u> menu)	4 - 6
4.2.2 Setting the Tracing Conditions in the Timing Analyzer (<u>TRACE</u> menu)	4 - 9
4.2.3 Acquired-data Scree in the Timing Analyzer (<u>DISPLAY</u> menu)	4 - 15

TR4726
LOGIC ANALYZER
OPERATION MANUAL

4.1 OUTLINE

4. BASIC OPERATION FOR MEASUREMENT

4.1 OUTLINE

This section describes the basic operating procedures for making measurements with the TR4726.

4.1.1 Menu Screens and Related Functions

The TR4726 uses the operation method based on the menu scheme. The screen that possesses more than one related menu items it referred to as the menu screen.

There are two types of menu screens: one type is opened by depressing a key from the MENU key group, and the other type is opened by the depressing either a key from the I/O key group or the AUTO key.

The former uses almost all areas of the CRT screen and plays a central role in measurement operations, and is thus referred to also as main menu screen. The latter is presented overlapping the corresponding main menu screen and plays an auxiliary role in measurement operations, and is thus referred to also as sub menu screen. These menu screens and related function names are shown in Figure 4-1.

The main menu screens used in basic measurement operations are opened using the CONFIG, SYMDEF, TRACE, and DISPLAY keys from the MENU key group.

On the CONFIG menu screen, it is possible to specify the input specifications of the TR4726. (Configuration) The function that is implemented on this menu screen is referred to as the CONFIG function.

On the SYMDEF menu screen, it is possible to define symbols and codes. (Symbol Definition) This function is referred to as the SYMDEF function.

On the TRACE menu screen, it is possible to set tracing conditions. (Trace Specification) This function is referred to as the TRACE function.

On the DISPLAY menu screen, it is possible for measured data to be displayed for analytical purposes. This function is referred to as the DISPLAY function.

On the UTILITY menu screen, it is possible to carry out services not associated directly with measurement operations. This function is referred to as the UTILITY function. (See section 8 for further details.)

On the GET/SAVE/FD menu screens, it is possible to carry out disk file processing operations associated with the particular main menu display. These functions are referred to as the SET, SAVE, and FD functions. (See section 5 for further details on each of these three functions.)

On the COMM menu screen, it is possible to set the necessary parameters for making communications with external devices via the RS-232C interface. This function is referred to as the COMM function. (See section 7 for details.)

Timing Analyzer

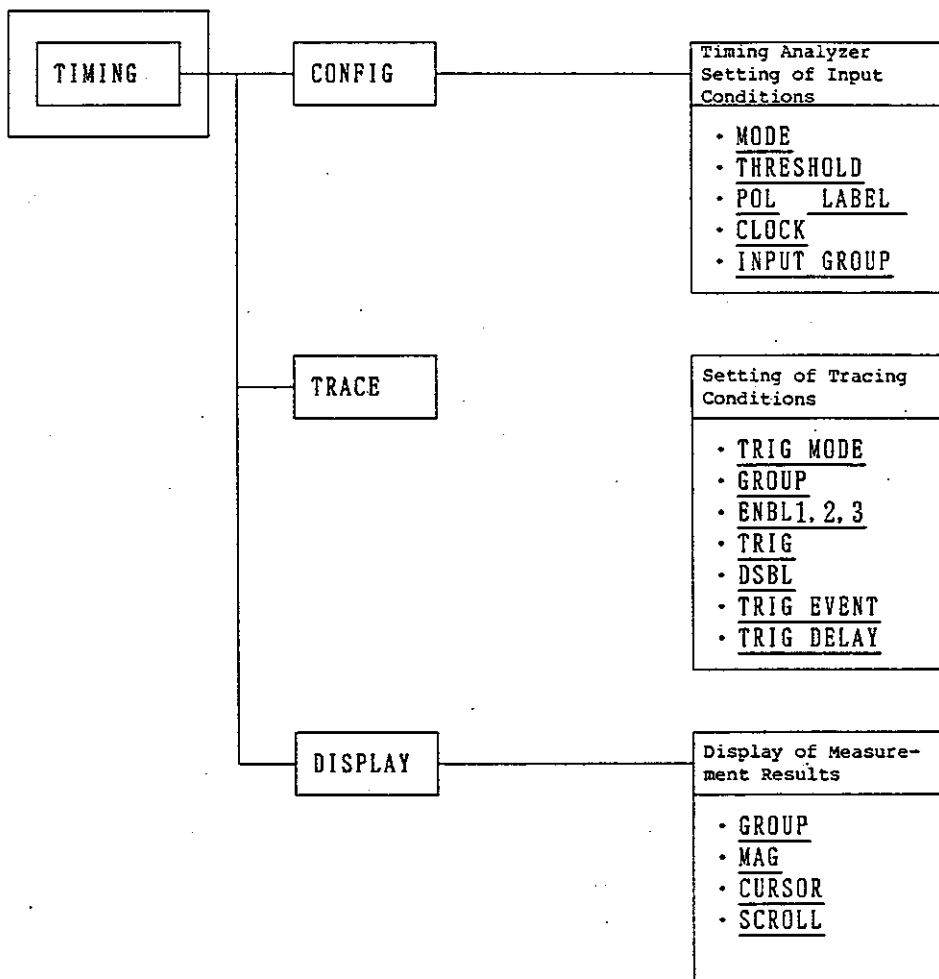

Figure 4-1 Menu Screen and Setting Functions (1/2)

Sub menu Screen

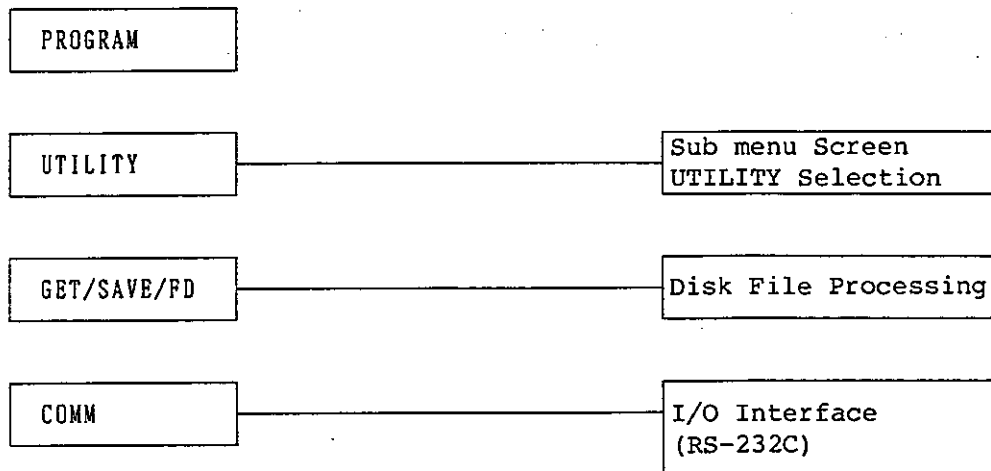

Figure 4-1 Menu Screen and Setting Functions (2/2)

TR4726
LOGIC ANALYZER
OPERATION MANUAL

4.2 MENU SCREEN OPERATIONS IN TIMING ANALYZER APPLICATIONS

4.2 MENU SCREEN OPERATIONS IN TIMING ANALYZER APPLICATIONS

This section describes the basic procedures for carrying out operations in the various menu screens when the TR4726 is used as a timing analyzer.

4.2.1 Configuration of Input Channels in the Timing Analyzer (CONFIG menu)

"Configuration of input channels" in the timing analyzer refers to the how to sampling of the 16-channel signals input via data probe E or F in order to utilize these signals as internal data.

The initial screen of the CONFIG menu is shown in Figure 4-2.

Figure 4-2 is followed by a description of the various data items that can be set on that screen. Use the SELECT or ENTRY key to set the data items.

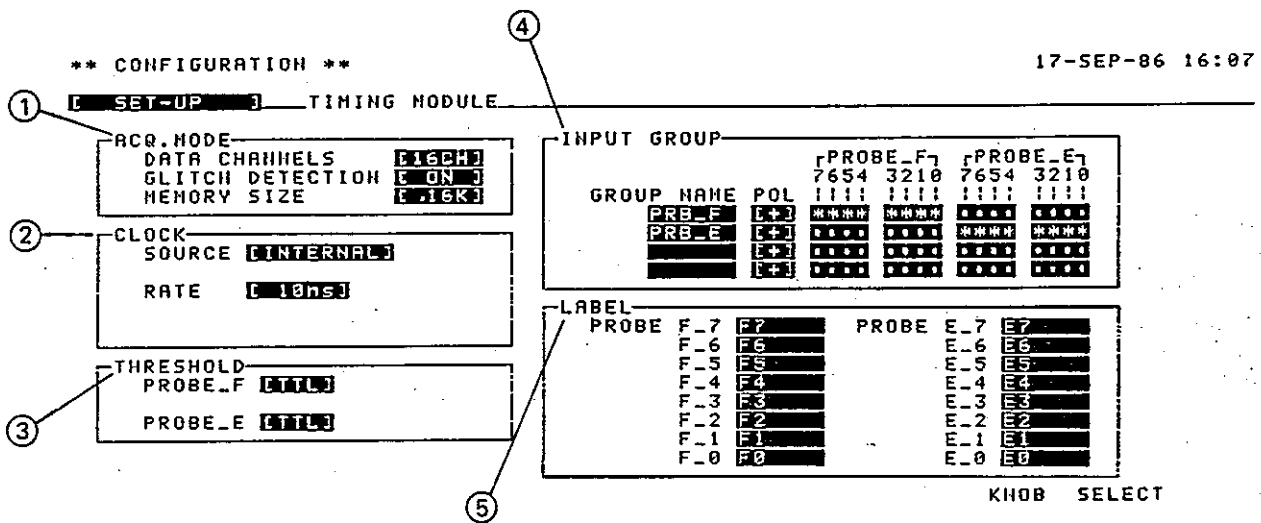

Figure 4-2 Initial Screen of the CONFIG Menu (Timing Analyzer)

(1) - MODE -

DATA CHANNELS: Select either [16CH] or [8CH] as data input channels.

In the TR4726, high-speed sampling (300 MHz sampling) uses the [8CH] mode.

TR4726
LOGIC ANALYZER
OPERATION MANUAL

4.2 MENU DISPLAY OPERATIONS IN TIMING ANALYZER APPLICATIONS

MEMORY SIZE: Select a memory size for the data acquisition memory.

The available sizes are 0.5 K, 1 K, 2 K, 4 K, 8 K, 16 K, 32 K, and 64 K. Note, however, that there is the following relationship between the number of input channels and the memory size:

No. of Data Channels	Sampling Clock Frequency	Memory Size Settings	
		Glitch ON	Glitch OFF
16	100 MHz or less	16 K or less	32 K or less
	150 MHz	-	32 K or less
8	150 MHz or less	32 K or less	64 K or less
	300 MHz	-	64 K or less

GLITCH DETECTION: Glitch detection ON/OFF.

The TR4726 can detect glitch (changes in input signal level within sampling intervals) that cannot be detected by ordinary timing analyzers since they sample input signals at the sampling edge of each internal clock.

When this function is set to ON, glitch data will be stored in the special memory for glitch.

(2) - CLOCK -

SOURCE: Selection of the sampling clock source.

Select either [INTERNAL] (internal clock) or [EXTERNAL] (external clock).

RATE: For [INTERNAL]
Select a clock rate for internal sampling clocks.

The available clock rates are 50 ms to 10 ns (1-2-5 steps), 6.7 ns, or 3.3 ns.

For [EXTERNAL]
The TR4726 has two channels for external clocks and two channels for the qualifer.

If [EXTERNAL] is selected as the clock source, this screen will change into one shown in Figure 4-3 to enable external clock setting.

TR4726
LOGIC ANALYZER
OPERATION MANUAL

4.2 MENU DISPLAY OPERATIONS IN TIMING ANALYZER APPLICATIONS

The screen displays the clock generation formula.

SCK = [K1] . Q1 . Q2 + [K2] . Q1 . Q2
 +: Logical sum
 .: Logical product
 K1, K2: Clock
 Q1, Q2: Qualifier
 ↑ ↓ : Clock rise/fall

Clock specification

↑ : Rise
 ↓ : Fall
 [] Clock not used.

Clock/qualifier specification

0, 1, X (Don't care)
 Initial value: X

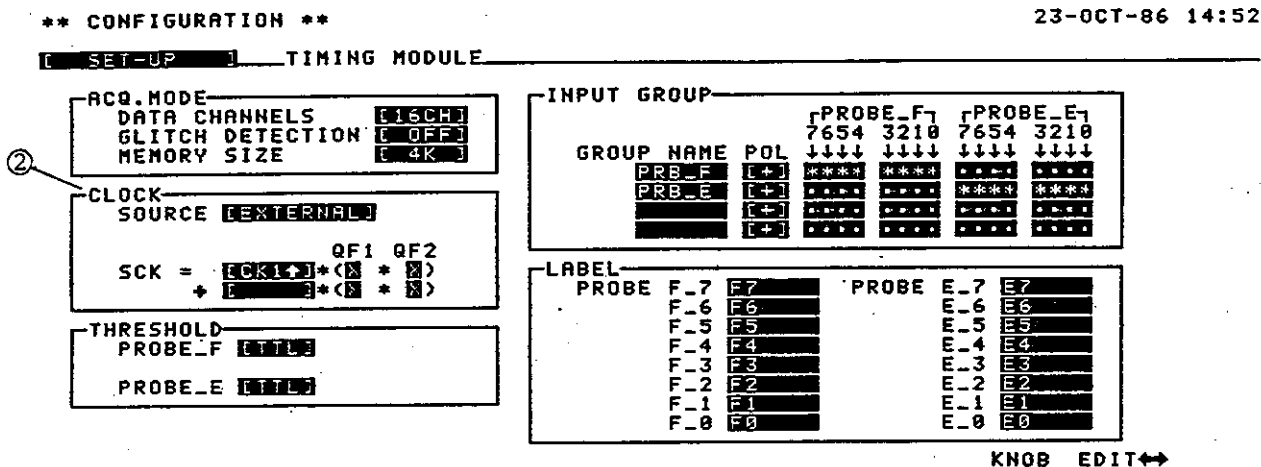

Figure 4-3 External Clock Setting

(3) - THRESHOLD -

PROBE_E: Select the desired threshold voltage for the input probe E using either [TTL], [ECL], or [VAR].

PROBE_F: Select the desired threshold voltage for the input probe F using either [TTL], [ECL], or [VAR].

The available VAR setting range is from -6.35 V to +6.35 V (in 50 mV steps).

TR4726
LOGIC ANALYZER
OPERATION MANUAL

4.2 MENU DISPLAY OPERATIONS IN TIMING ANALYZER APPLICATIONS

(4) - INPUT GROUP -

NAME: The minimum units for collective handling of several data input channels is defined as GROUP.

Input data manipulated in GROUP can be input once the asterisk (*) has been input.

Up to four group names can be defined. On the initial screen of this menu, PROBE_E and PROBE_F are predefined.

POL: Specify the logical polarity during DISPLAY/TRACE.

(5) - LABEL -

LABEL: Input signals from data probe E and data probe F are each preassigned a specific name so that they can be freely referred to during the display of acquired data. For data probe E, specific label names E7 to E0 are preassigned on a channel basis; for data probe F, specific label names F7 to F0 are preassigned on a channel basis.

These label names can be freely defined by the user.

Up to six characters are available as a label name.

. Clock qualifier function

This function validates only the clocks that match the conditions which have been set for the clock qualifier. Only the validated clocks are fetched.

This function is therefore effective for seizing specific clock portions and for memory savings.

4.2.2 Setting the Tracing Conditions in the Timing Analyzer (TRACE menu)

TRACE specifies the measuring mode and sets the tracing conditions which form the most important part of the measuring conditions.

The TR4726 provides various types of trace control functions for sophisticated timing analysis.

1. 4-level sequential trigger/reset (ENABLE 3-stage + trigger/DISABLE)
 - (1) ENABLE function
 - (2) DISABLE function
 - (3) TRIGGER function
 - . Match pattern TRUE/FALSE
 - . GLITCH
 - . EDGE
 - . Serial pattern

TR4726
LOGIC ANALYZER
OPERATION MANUAL

4.2 MENU DISPLAY OPERATIONS IN TIMING ANALYZER APPLICATIONS

2. FILTER function
3. EVENT count function
4. DELAY count function

ENABLE

It is possible to specify a precedence pattern for trigger recognition. Up to three sequences can be configured.

DISABLE

The sequence by the precedence pattern (ENABLE) used for trigger recognition is initialized.

TRUE/FALSE

TRUE When the event that has been specified for a trigger occurs, this will be recognized as trigger.

FALSE ... Trigger recognition is made using the desired data other than the event that has been specified for a trigger.

Inversion from FALSE to TRUE does not take place upon glitch or signal edges.

GLITCH

Triggers are recognized when a glitch occurs between sampling intervals.

EDGE

Triggers are recognized when the transient state (rise/fall) of a data pattern occurs.

Serial pattern

Triggers are recognized using the serial data pattern (serial bit array) of a serial communications device.

FILTER

This function identifies only the events that have persisted past the filter-set time.

In the TR4726, the filtering time can be set to each sequence level. This function is effective for recognizing correct data by eliminating indeterminate data (hazards and skews) associated with high-speed sampling.

EVENT

It is possible to specify the desired number of times that triggers are to occur.

TRIGGER POSITION

The positional relationship between the trigger point that has been obtained by a trigger pattern and the oldest data is specified.

TR4726
LOGIC ANALYZER
OPERATION MANUAL

4.2 MENU DISPLAY OPERATIONS IN TIMING ANALYZER APPLICATIONS

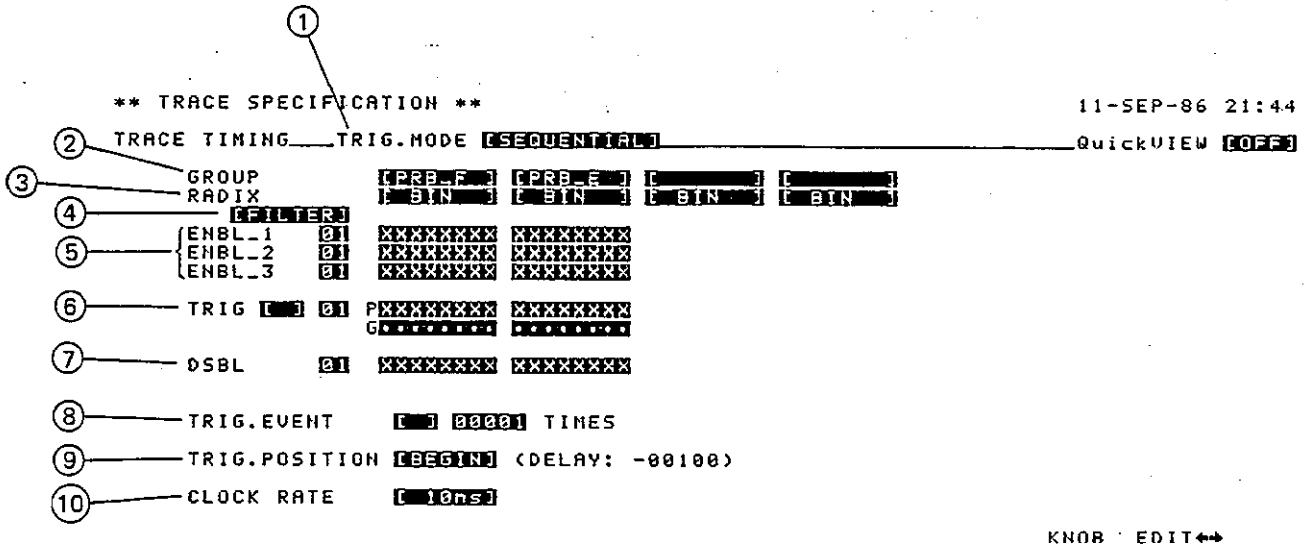

Figure 4-4 TRACE Menu Screen

- (1) The items to be set on the menu screen
Each of the items to be set on the menu screen shown in Figure 4-4 is described below.
- (1) TRIG MODE: Selects either the SEQUENTIAL or SERIAL mode.
 - SEQUENTIAL ... The trigger works as a 4-level sequential trigger.
 - SERIAL The trigger works as a serial trigger.

The channel having this trigger function is CH_0 of PROBE_E.
 - (2) GROUP: Refer to the GROUP that has been defined on the CONFIG menu screen.
 - (3) RADIX: Selects the ENABLE, TRIG, or DISABLE setting pattern radix. During radix conversion, where a new radix conversion cannot be made using the "X", "↑", or "↓" key is indicated an "?".
 - (4) FILTER/EVENT: Sets a filter value or an event for the ENABLE, TRIG, or DISABLE function. The available setting range is from 1 to 15.
 - (5) ENBL 1, 2, 3: Specifies a precedence pattern for trigger pattern recognition.

TR4726
LOGIC ANALYZER
OPERATION MANUAL

4.2 MENU DISPLAY OPERATIONS IN TIMING ANALYZER APPLICATIONS

- ⑥ TRIG: [] ... Sets the trigger pattern to TRUE.
[≠] ... Sets the trigger pattern to FALSE.
P Set a trigger pattern and specifies an edge input channel.
Either 0, 1, X, ↑, or ↓ can be specified.
You can specify the edge for only one of the available input channels.
G Specifies a glitch input channel.
Specify either "." or "*".
(*: The particular channel is recognized as the glitch input channel.
To specify a glitch input channel set the trigger pattern.

NOTE 1

During trigger, the trigger position may become indeterminate if the trigger pattern occurs before the clock counter indicates "50".

If this is the case, change the trigger position to [VAL].

NOTE 2

During sequential trigger, if the TRIG POSITION is set to VAL, the trigger point cannot be determined for any trigger patterns occurring before the clock counter indicates "14".

- ⑦ DSBL: Specifies a DSBL pattern for trigger sequence resetting.
Set either 0, 1, or X.
- ⑧ TRIG EVENT: Sets an event counter value.
The available setting range is from 1 to 65535 events.
- ⑨ TRIG POSITION: Specifies the position of the trigger word within the data acquisition memory. If a positive value is set using VAL, then this indicates the data existing before triggering is to occur is acquired.

TR4726
LOGIC ANALYZER
OPERATION MANUAL

4.2 MENU DISPLAY OPERATIONS IN TIMING ANALYZER APPLICATIONS

- ⑩ **CLOCK RATE:** Sets a sampling clock rate.

- ⑪ **TRIG PATTERN:** Describes a trigger pattern example. Trigger search takes place in a 16-bit pattern using 0, 1, or X. At the left and right ends of the 16-bit pattern are the starting bits and ending bits, respectively. The ending bits form the trigger (T) of the DISPLAY menu.

- ⑫ **TRIG EVENT:** Specifies the number of repetitions (events) of the trigger pattern.

Use [↵] to select the number of repetitions of pattern, and use [] to select the number of clocks. Use entry keys 0 to 9 to set these two parameters.

- ⑬ **TRIG POSITION:** Specifies the position of the trigger word within the data acquisition memory. Either [BEGIN], [CENTER], [END], or [VAR] can be selected.

For [VAR], if a positive value is set, then the data existing before triggering is to occur is acquired.

The trigger position displayed on the DISPLAY menu is indicated by the last four bits of the TRIG PATTERN.

- ⑭ **QUICK VIEW:** Selects either Quick View ON or Quick View OFF. Quick View ON causes automatic repetition of analysis and also enables each parameter of the DISPLAY menu to be freely changed even during analysis.

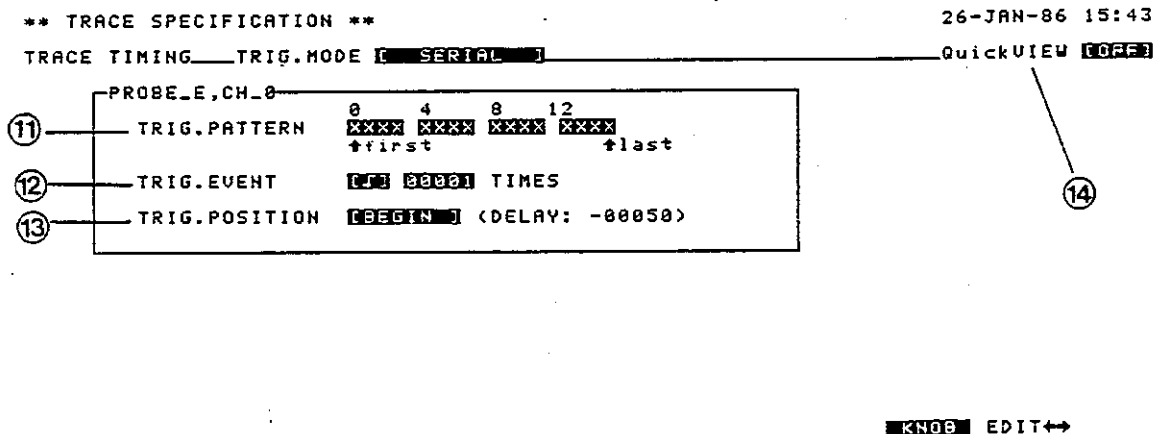

Figure 4-5 TRACE Menu (SERIAL) Display

TR4726
 LOGIC ANALYZER
 OPERATION MANUAL

4.2 MENU DISPLAY OPERATIONS IN TIMING ANALYZER APPLICATIONS

(2) Conditions for setting the trigger

The trigger setting process as shown in Figure 4-6.

When the GLITCH/EDGE function is used, the trigger will be set to the following conditions:

T . (G + E)

- T: Trigger pattern
- G: Glitch setting
- E: Edge setting

Sampling points

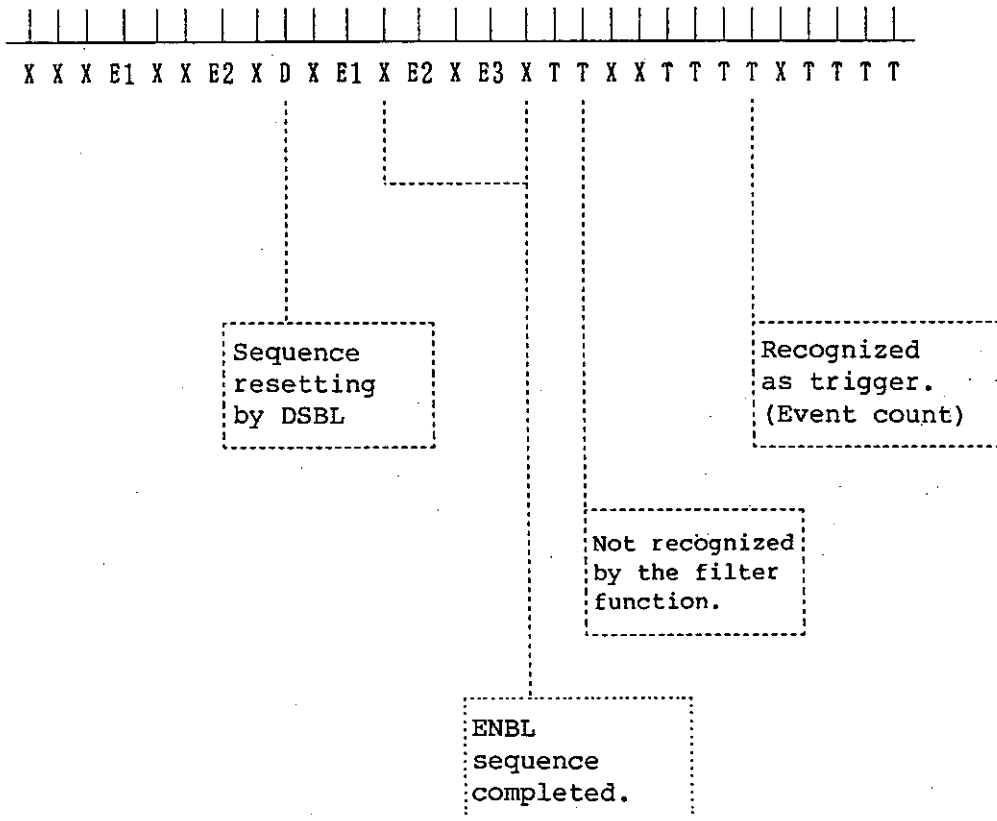

- E1: ENBL1 pattern
 - E2: ENBL2
 - E3: ENBL3
 - D : DSBL
 - T : TRIG
- (Trigger filter: 4)

Figure 4-6 Trigger Setting Process

4.2 MENU DISPLAY OPERATIONS IN TIMING ANALYZER APPLICATIONS

4.2.3 Acquired-data Scree in the Timing Analyzer (DISPLAY menu)

(1) Display format and menu item setting

The DISPLAY function displays the measured data stored within the data acquisition memory or within a file on the CRT screen in a format suitable for analysis. The initial screen of the DISPLAY menu is shown in Figure 4-7.

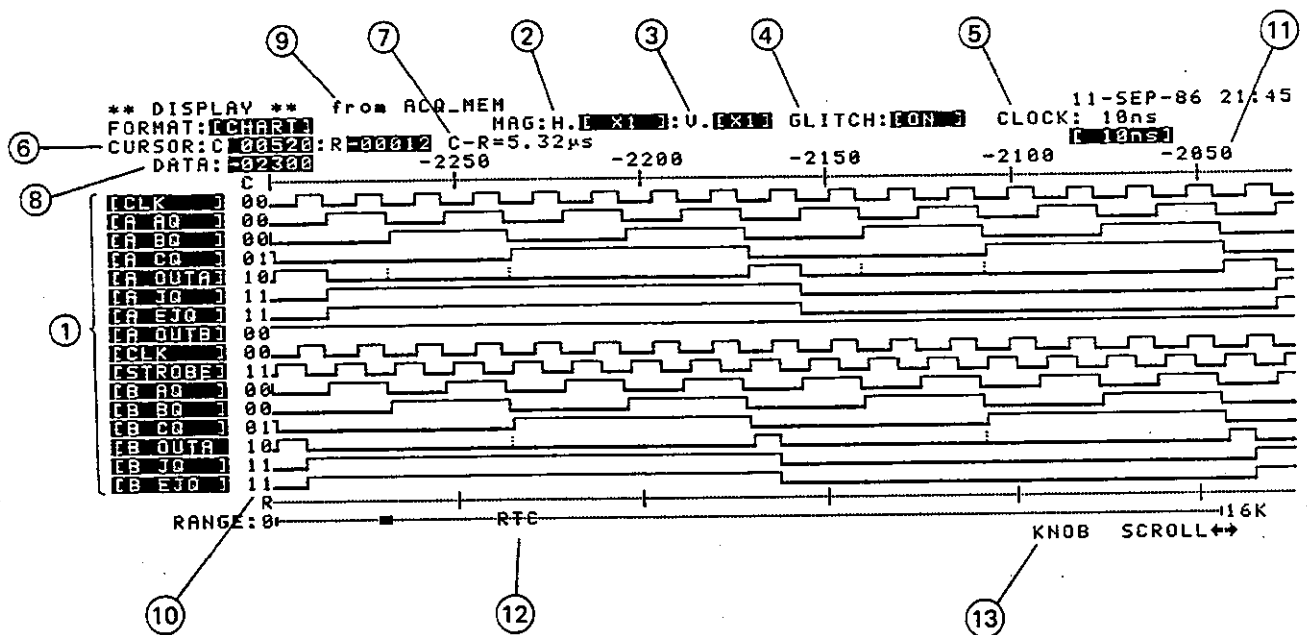

Figure 4-7 Initial DISPLAY Menu

Input data from data probes E (7 to 0) and F (7 to 0) are displayed in the order of probe label name.

The initial menu screen is displayed with a horizontal magnification of x1. The measured data is displayed at the maximum resolution level.

The data source is displayed at the left end of the uppermost line. The data source indicates where the data currently being displayed has been sent from. If the data source is displayed as ACQ_MEM, then the data has come from the data acquisition memory. If the data source is displayed as a file name, then the data has come from the corresponding file.

The data source will be displayed as ACQ_MEM if data has been sent immediately after measurement.

TR4726
LOGIC ANALYZER
OPERATION MANUAL

4.2 MENU DISPLAY OPERATIONS IN TIMING ANALYZER APPLICATIONS

How to set the various menu items is described below.

- ① Label: When this menu screen is first displayed, label names are displayed in the order of F7 to F0 (data probe F) first and then E7 to E0 (data probe E) next.

If a label is first defined on the CONFIG menu screen, then that user label will be used.

Use the SELECT key to be display the data in the desired order. In addition, the same data can be displayed repeatedly. Data, however, will not be displayed if a blank label is selected with the SELECT key.

- ② MAG: H: Specifies a horizontal magnification factor.

The available factor is ALL, HALF, x1, x2, x4, or x8. The reference point for magnification will be automatically set at the cursor position if a cursor (C-cursor) is already displayed on the screen.

If a cursor is not yet displayed on the screen, the reference point will be automatically set at the left-end data position.

The following table represents the relationship between the horizontal magnification factor and the number of data samplings displayed on the screen:

Horizontal Magnification Factor	No. of Data Samplings Displayed
ALL	*1 Memory size
HALF	*2 1/2 of memory size
x1	276 data samplings
x2	138 data samplings
x4	69 data samplings
x8	34 data samplings

*1: ALL or HALF compresses displayed screen in a simplified format. For a magnification factor of HALF with a memory size of 0.5 K, however, the noncompressed displayed screen is at the maximum resolution level.

*2: For a memory size of 64 K, the magnification interval becomes halved as the memory size decreases by half.

TR4726
LOGIC ANALYZER
OPERATION MANUAL

4.2 MENU DISPLAY OPERATIONS IN TIMING ANALYZER APPLICATIONS

- ③ MAG: V. Specifies the vertical magnification (x1 or x2).
If x1 is selected for 16 input channels, then data corresponding to the 16 channels will be displayed.
If x2 is selected, data corresponding to the 8 channels will be displayed, with the data height doubled.
- If x1 is selected for 8 input channels, data corresponding to the 8 channels will be displayed in the upper data position (no data will be displayed in the lower data position).
- If x2 is selected, data corresponding to the 8 channels is displayed with the data height doubled.

- ④ GLITCH: Turns ON/OFF glitch data display.

Glitch data will be displayed in broken lines between data samplings.



- ⑤ CLOCK: The normally displayed value is the sampling clock rate of the displayed data. To change the clock rate of the next sampling operation, select the value directly below the menu item.

This item is the same as the -CLOCK- selection in the CONFIG menu screen.

- ⑥ CURSOR: Specifies where the cursor is displayed on the screen. The cursor can be displayed as either cursor C (used as the base for display-data magnification) or cursor R (used as the base for the time difference).

Use the CURSOR:C menu item to specify the position of cursor C in number of clocks. The specified position will be used both for displaying the time difference between cursor R and cursor C, and for displaying the magnification.

Use the CURSOR:R menu item to specify the position of cursor R in number of clocks with the trigger point as the base. This number of clocks provides a base for displaying the time difference between cursor R and cursor C.

TR4726
LOGIC ANALYZER
OPERATION MANUAL

4.2 MENU DISPLAY OPERATIONS IN TIMING ANALYZER APPLICATIONS

- ⑦ Cursor-to-cursor time: The time difference between cursor C and difference (C-R) cursor R is displayed.
- ⑧ DATA: The first position of data display can be specified.
- ⑨ Displayed-data source: This item indicates from where the data currently being displayed has been sent.

The following three types of displayed-data sources are provided:

From ACQ_MEM : Displays the ACQ memory contents.
ACQ_MEM is displayed measurement.

From REF_MEM : Displays the REF memory contents.

From file name: Displays data from a file.

- ⑩ Cursor C/R readout: Display the logical levels of data in the positions of cursors C and R.
- ⑪ Scale: The horizontal-axis scale displays the time difference between the trigger point and displayed data. Here, such a time difference is displayed in number of sampling clocks. The following table represents the relationship between the horizontal-axis scale and displayed data:

Horizontal Magnification Factor	Horizontal-Axis Scale Interval
ALL	*2 For every 8K samplings
HALF	*2 For every 4K samplings
x1	For every 50 samplings
x2	For every 20 samplings
x4	For every 10 samplings
x8	For every 5 samplings

- ⑫ Trigger point: Displays where a trigger has occurred by a T mark.

TR4726
LOGIC ANALYZER
OPERATION MANUAL

4.2 MENU DISPLAY OPERATIONS IN TIMING ANALYZER APPLICATIONS

- ⑬ KNOB: Scrolls the acquired-data display. In addition, the functions described below are used in conjunction with the (KNOB) key. The selected function name of the key is displayed at the lower right end of the screen.
- SCROLL← → : Scrolls horizontally the data display.
- SCROLL↑ ↓ : Scrolls vertically the data display.
This function, however, is valid only for 16 input channels with a vertical magnification factor of x2.
- CURSOR_C : Scrolls cursor C.
- CURSOR_R : Scrolls cursor R.
- CURSOR C&R : Simultaneous scrolling of both cursor C and cursor R with their positional relationship maintained.
- EDIT ← → : Editing of the menu items within the DISPLAY menu. Move the prompt to the desired menu item and then carry out the edit operation.
- SELECT : Changes the desired data setting item in a similar manner to that of operation of the SELECT key group. On the DISPLAY menu screen, the following items can be changed:
- . MAG:H, MAG:V
 - . GLITCH ON/OFF
 - . CLOCK
 - . Label
- PAGE : Scrolls data page by page. The number of data samplings that can be scrolled per page is shown in the table below for each horizontal magnification factor:

TR4726
LOGIC ANALYZER
OPERATION MANUAL

4.2 MENU DISPLAY OPERATIONS IN TIMING ANALYZER APPLICATIONS

Horizontal Magnification Factor	No. of Data Samplings per Page
ALL	No scrolling
HALF	1/2 of memory size
x1	240 data samplings
x2	120 data samplings
x4	60 data samplings
x8	30 data samplings

- ⑭ SRCH: Searches acquired data for a specific pattern. When the pattern to be searched is described immediately to the right of the label, the acquired data can be searched in the left direction (the direction of smaller data numbers) using the INSERT key or in the right direction (the direction of larger data numbers) using the DELETE key. Searched data will be highlighted (character units). In compressed display, since data other than searched data is also included in it, the entire display must be magnified for verification.
- ⑮ FORMAT: Selects either [CHART] or [LIST] as the display format of the acquired data. The default setting for the format is [CHART]. To select [LIST] use either the rotary knob or the SELECT key. Figure 4-8 shows [LIST] screen format.

TR4726
LOGIC ANALYZER
OPERATION MANUAL

4.2 MENU DISPLAY OPERATIONS IN TIMING ANALYZER APPLICATIONS

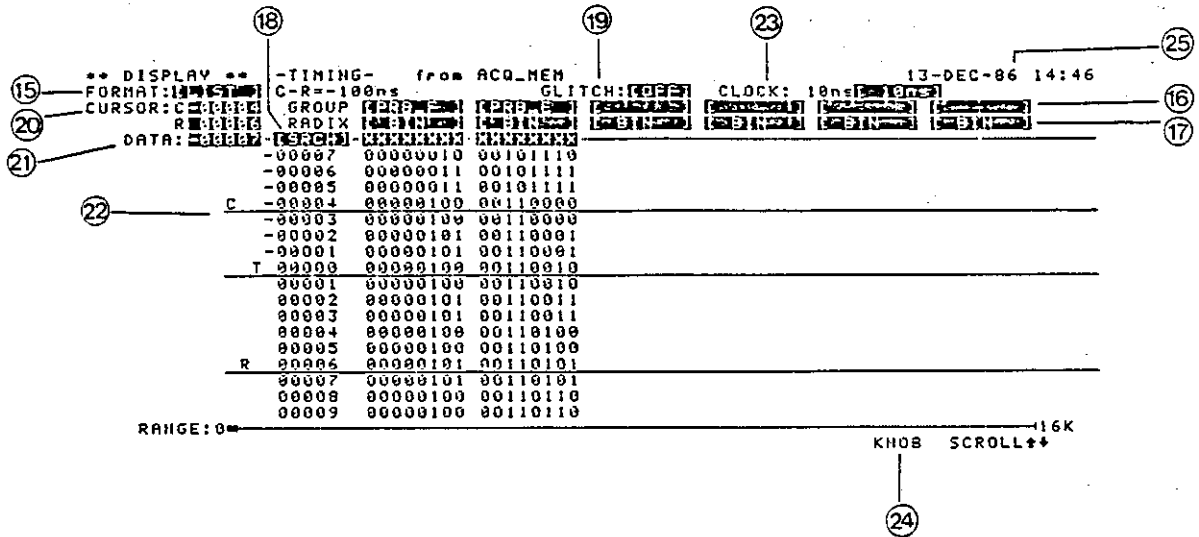

Figure 4-8 DISPLAY [LIST] Menu Screen

- 16** GROUP: Displays list in either the BIN, OCT, DEC, HEX, or ASCII format on a group basis. The group name that has been set in the CONFIGURATION menu screen is displayed. (Up to four group names can be registered.)

The order in which the group names are displayed can be specified by moving the prompt to the desired position using the rotary knob or the EDIT key and then selecting the display order using the SELECT key or the rotary knob.

- 17** RADIX: Displays each group in either binary, octal, decimal, hexadecimal, or ASCII format.

The display format must be selected by moving the prompt using the EDIT key or the rotary knob and then selecting one of the above five formats using the SELECT key or the rotary knob. Note, however, that the ASCII format is selectable only for 7- or 8-channel configurations.

- 18** SRCH: Searches acquired data for a specific pattern. First describe the desired pattern on the portion highlighted on the right side of the screen and then scroll the data display upwards (in the direction of smaller data numbers) using the INSERT key or downwards (in the direction of larger data numbers) using the DELETE key. Searched data will be highlighted.

4.2 MENU DISPLAY OPERATIONS IN TIMING ANALYZER APPLICATIONS

- ①9 GLITCH: This function is valid only when the GLITCH DETECTION item is set to [ON] on the CONFIGURATION menu screen. When the prompt is moved using the EDIT key or the rotary knob and then [ON] is selected using the SELECT key or the rotary knob, the background of the corresponding data (characters) will be displayed in half-tone if GLITCH data exists on the screen.
- ②0 CURSOR: Specifies the position on the screen where cursor C or cursor R is displayed. Use CURSOR:C to specify cursor C, and use CURSOR:R to specify cursor R.
- ②1 DATA : Specifies the first position of the data displayed.
- ②2 Cursor display: Either cursor C, cursor R, or both cursors C and R can be moved using the rotary knob by selecting the respective functions of the key located to the left of the rotary knob.
- ②3 CLOCK : The value being displayed in normal form denotes the sampling clock rate of the displayed data. Selecting of the menu item on the right side of this data item changes the next-sampling clock rate. This function is similar that of -CLOCK- selection on the CONFIGURATION menu.
- ②4 KNOB (Rotary knob): Scrolls the acquired data display, moves cursor C or R, and selects menu items. Use the key located on the left side of the rotary knob to select between these three functions.
The selected function name of the key will be displayed on the right side of the screen.
- SCROLL ↑ ↓ : Scrolls data.
- CURSOR_C ↑ ↓ : Moves cursor C.
- CURSOR_R ↑ ↓ : Moves cursor R.
- CURSOR_C&R ↑ ↓ : Simultaneously moves both cursors C and R with their positional relationship maintained.

TR4726
LOGIC ANALYZER
OPERATION MANUAL

4.2 MENU DISPLAY OPERATIONS IN TIMING ANALYZER APPLICATIONS

- EDIT ← → : Edits the menu items within the DISPLAY menu. To edit move the prompt the desired menu item.
- SELECT : If the prompt specifies [], then the same function as that of the SELECT key on the panel can be used. When the rotary knob is turned clockwise, it becomes as a NEXT key; when the rotary knob is turned counterclockwise, it becomes a PREV key.

- ②5 Calendar: Displays the calendar in the year/month/day/hour/minute format. See "Utility Functions and Operations" for details on how to set the calendar.

MEMO



A large, empty rectangular area with rounded corners, enclosed by a dashed border, intended for writing the memo's content.

TR4726
LOGIC ANALYZER
OPERATION MANUAL

5. DISK FILE PROCESSING FUNCTIONS AND OPERATIONS

TABLE OF CONTENTS

5. DISK FILE PROCESSING FUNCTIONS AND OPERATIONS	5 - 3
5.1 PRELIMINARY KNOWLEDGE FOR DISK FILE PROCESSING	5 - 3
5.1.1 Outline of Disk File Processing	5 - 3
5.1.2 Disk Handling Precautions	5 - 4
5.1.3 System Disks and Data Disks	5 - 6
5.1.4 Classification of Files	5 - 6
5.1.5 Starting and Erasing the Submenu Screen by the GET/SAVE/FD Functions	5 - 9
5.2 GET FUNCTIONS AND OPERATIONS	5 - 10
5.2.1 Ordinary GET Function and Operations	5 - 10
5.2.2 QuickGET Function and Operations	5 - 10
5.3 SAVE FUNCTIONS AND OPERATIONS	5 - 12
5.3.1 Ordinary SAVE Function and Operations	5 - 12
5.3.2 Quick SAVE Function and Operations	5 - 12
5.4 DIRECTORY FUNCTIONS AND OPERATIONS	5 - 14
5.4.1 DIRECTORY-of-MENU Function and Operations	5 - 14
5.4.2 DIRECTORY-of-ALL Function and Operations	5 - 14
5.5 REGISTER FUNCTION AND OPERATIONS	5 - 15
5.6 PURGE FUNCTION AND OPERATIONS	5 - 16
5.7 DELETE FUNCTION AND OPERATIONS	5 - 18
5.8 FORMAT FUNCTION AND OPERATIONS	5 - 19
5.9 RENAME FUNCTION AND OPERATIONS	5 - 20
5.10 COPY FUNCTION AND OPERATIONS	5 - 21
5.11 STATUS FUNCTIONS AND OPERATIONS	5 - 23
5.11.1 STATUS-of-FILES Function and Operations	5 - 23
5.11.2 STATUS-of-DISK Function and Operations	5 - 23

TR4726
LOGIC ANALYZER
OPERATION MANUAL

5.1 PRELIMINARY KNOWLEDGE FOR DISK FILE PROCESSING

5. DISK FILE PROCESSING FUNCTIONS AND OPERATIONS

5.1 PRELIMINARY KNOWLEDGE FOR DISK FILE PROCESSING

5.1.1 Outline of Disk File Processing

A series of measurements can be made using the basic measurement functions mentioned in the preceding section.

However, under complicated measuring conditions or when measured data are to be handled in large quantities, these functions alone may not suffice for efficient measurement.

The TR4726 is provided with disk file processing functions that save the measuring conditions, measured data, etc. within files for future use.

Disk file processing can be carried out at any time while the CONFIG, SYMDEF, TRACE, DISPLAY, or PROGRAM menu screen is displayed for data input. (Disk file processing cannot be done during measurement, input/output operations, or display of the UTILITY menu.)

Use the GET, SAVE, and FD keys to perform the disk file processing tasks.

The GET function reads data from the files and display it on the main menu screen.

The SAVE function writes the data appearing on the main menu screen into files.

The FD function, which consists of disk file processing commands, is an auxiliary function used for copying, erasing, etc. of files.

In the TR4726, two types of data can be subjected to disk file processing: data within the built-in floppy disk drive, displayed as F0, and data within an external floppy disk drive, displayed as F1.

The TR4726 has name-assigned file systems built into its operating system that operate the above two drive units.

Therefore, it is possible to carry out filing operations in a similar manner to that of a general-purpose computer system that explicitly uses file names.

This operation method is highly flexible for managing files because it can handles any file name. However, this method is very troublesome because it requires that a file name be input for each operation.

TR4726
LOGIC ANALYZER
OPERATION MANUAL

5.1 PRELIMINARY KNOWLEDGE FOR DISK FILE PROCESSING

Since such a computer-like file operation method is quite different from those required for measurement using the TR4726, this logic analyzer provides the Quick Get/Save functions to allow the ordinary GET/SAVE functions to be used without keying in any file names.

With the Quick Get/Save functions, the user can utilize new functions without any new burden on him (or her) since the naming and management of files is performed by the TR4726 itself.

5.1.2 Disk Handling Precautions

Protect floppy disks from dust and dirt, moisture, low temperatures, magnetism, etc. while using or storing them.

Always use double-sided, 3.5-inch floppy disks.

Such floppy disks are designed so that their protective covers will open when the disks are inserted into the auto-shutter type disk drives.

Usually, the protective cover remains closed and, unlike conventional 8-inch or 5.25-inch floppy disks, the disk has an unexposed surface.

In addition, these floppy disks are each fitted with a write-protect mechanism. Figure 5-1 illustrates how to use of the write-protect tab.

The system disks are shipped write-protected.

TR4726
LOGIC ANALYZER
OPERATION MANUAL

5.1 PRELIMINARY KNOWLEDGE FOR DISK FILE PROCESSING

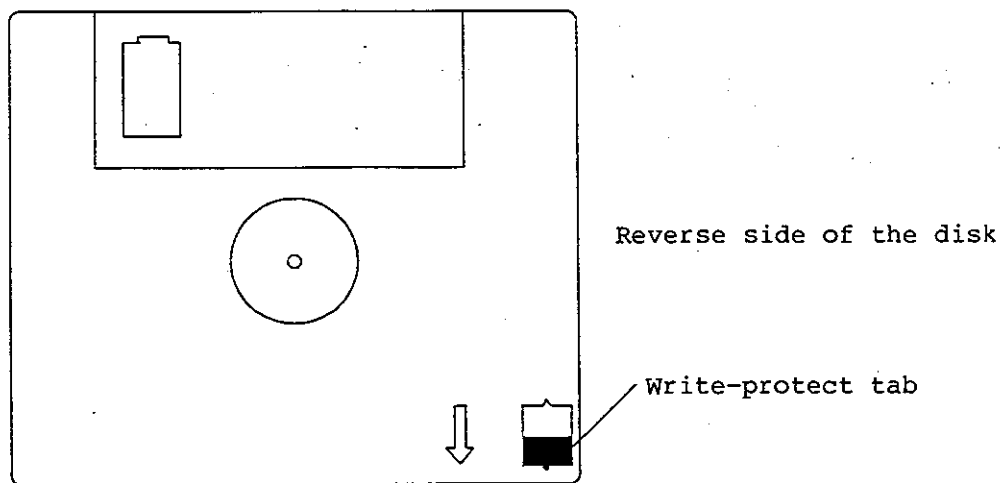

(a) Write-protected.

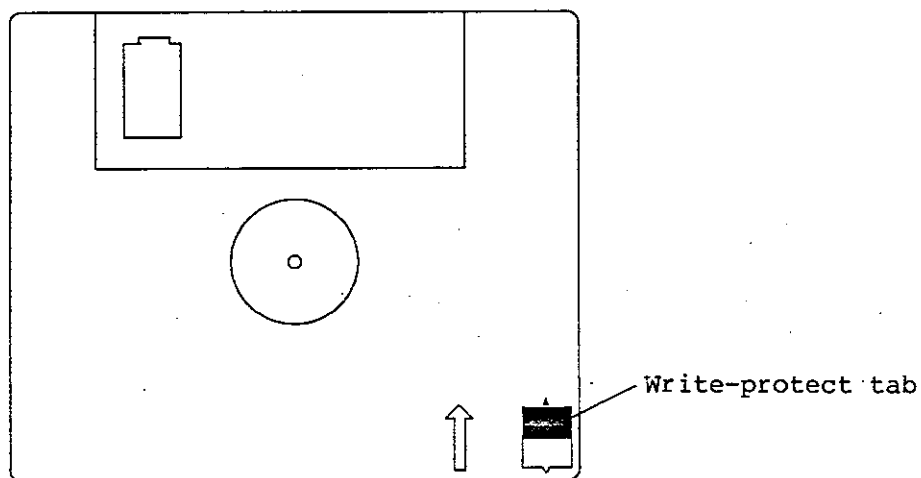

(b) Not write-protected.

Figure 5-1 How to Use the Write-Protect Tab

The specifications of floppy disk are as follows:

- . Disk life : 3×10^6 passes/track
- . Operating temperature range: 10°C to 60°C
- . Operating humidity range : 8% to 80% RH (Non-condensing.)
- . Storage temperature range : 4°C to 53°C
- . Storage humidity range : 8% to 90% RH (Non-condensing.)

TR4726
LOGIC ANALYZER
OPERATION MANUAL

5.1 PRELIMINARY KNOWLEDGE FOR DISK FILE PROCESSING

5.1.3 System Disks and Data Disks

Two types of floppy disks are used on the TR4726: system disks and data disks.

Two system disks are supplied as attachments to the OPT4726 +70/OPT4726 +75 timing module and each personality kit. Each of the two system disks has the same contents.

The system disks contain a large portion of the system software which controls the TR4726, and are upgraded periodically for improved functions.

5.1.4 Classification of Files

Files within a disk can be identified according to file name, attribute, and management grouping. The file attribute denotes the type of data contained in the file, and the file management grouping denotes the person responsible for managing the file. These classifications are intended only to maintain the consistency of file processing within the TR4726 and need not be paid attention to during normal operations. (Such classifications are greatly convenient for operation and provide a high degree of sophistication.)

The file name consists of a name part and an extender part as shown below.

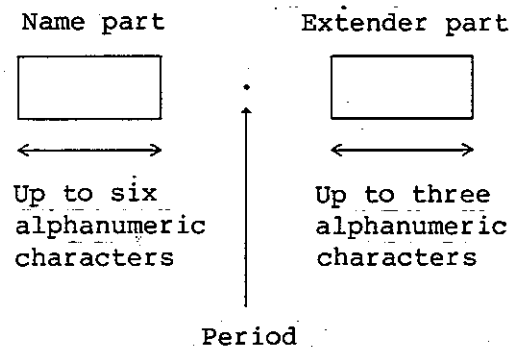

The file name is valid, as long as even a single character is included in the name part. Therefore, "1", "1.", "A.1", etc. are all correct file names, even though "1" is treated as a file name equivalent to "1." by the TR4726. A special file name may be used for a particular file attribute and file management grouping.

TR4726
LOGIC ANALYZER
OPERATION MANUAL

5.1 PRELIMINARY KNOWLEDGE FOR DISK FILE PROCESSING

There are nine types of file attributes provided according to the contents of the file.

- . SETUP : Holds the CONFIG main menu screen data.
Holds the TRACE main menu screen data.
- . SYMDEF : Holds the SYMDEF main menu screen data.
- . DISP_S : Holds the DISPLAY main menu screen data if the measuring mode is TRACE STATE. (For the timing analyzer, only this attribute is provided.)
- . DISP_T : Holds the DISPLAY main menu screen data if the measuring mode is TRACE TIMING. (For the timing analyzer, only this attribute is provided.)
- . DISP_ST: Holds the DISPLAY main menu screen data if the measuring mode is TRACE S&T (S → T) or TRACE S&T (T → S). (For the S&T analyzer, all the file attributes of DSP_S, DSP_T, and DSP_ST can be taken.)
- . PROG : Holds the PROGRAM main menu screen data.

When files are to be used on the main menu screen, file operation can be a much simplified by utilizing these file attributes to make the main menu screen act as if it were a directory of the file system.

The file name and the file attribute can be checked using the DIRECTORY function (see subsection 5.4.2).

TR4726
 LOGIC ANALYZER
 OPERATION MANUAL

5.1 PRELIMINARY KNOWLEDGE FOR DISK FILE PROCESSING

Table 5-1 Classification of Files

Menu Screen	File Attribute	File Management Grouping	File name
CONFIG TRACE	SETUP	User file	Freely assigned*
		System-saved file	SETUP.S1 - SETUP.S99
		Registered file	SETUP.REG
SYMDEF	SYMDEF	User file	Freely assigned*
		System-saved file	SYMDEF.S1 - SYMDEF.S99
		Registered file	SYMDEF. REG
DISPLAY	DISP_S DISP_T DISP_ST	User file	Freely assigned*
		System-saved file	DISP.S1 - DISP.S99
		Registered file	DISP.REG
PROGRAM	PROG	User file	Freely assigned*
		System-saved file	PROG.S1 - PROG.S99
		Registered file	PROG.REG

*: For the extender part, however, it is not possible to use. EXE, .SYS., .Sn (n: Numeral) or ,REG.

Each file is classified as one of the following three types according to the file management grouping: (1) user file; (2) system-saved file, and; (3) registered file.

. User files:

Files of this type are created by assigning the desired file names to the files by the user. The files themselves or the file contents can be freely erased using the DELETE function (section 5.7), the RENAME function (section 5.9), and/or the COPY function (section 5.10). The user himself (or herself) must manage such files. For the extender part, it is not possible to use EXE, SYS, Sn (n: Numeral), or REG.

TR4726
LOGIC ANALYZER
OPERATION MANUAL

5.1 PRELIMINARY KNOWLEDGE FOR DISK FILE PROCESSING

. System-saved files:

Files of this type are created by the QuickSAVE function (section 5.3), and are named and managed by the TR4726. Unlike user files, it is not possible for the user to erase the desired system-saved file(s). To erase these files the user must use the PURGE function (section 5.6). All the files must be erased collectively in the order that they have been created. (For this erasure, neither the DELETE/RENAME functions are available, nor the destination of the COPY function can be made.)

To partially save the series of system-saved files, first copy those contents into a user file using the COPY function and then erase all the system-saved files using the PURGE function.

. Registered files:

These files come under the QuickGET function (section 5.2). A registered file is created by registering a user or system-saved file for each main menu screen using the REGISTER function (section 5.5). The original file can be erased once the registration has been completed.

Up to a maximum of 199 files (the total of the above three types of files) can be created within a user disk. Note, however, that it may not be possible to create up to 199 files since each file varies in size with the file contents. The maximum available capacity of a user disk is 2530 blocks (1 block = 632.5 KB for 256B). The number of files, total size (in blocks), available area size, etc. of a user disk can be checked using the STATUS function (section 5.11).

5.1.5 Starting and Erasing the Submenu Screen by the GET/SAVE/FD Functions

To perform disk file processing, first press one of the GET, SAVE, and FD keys and overlap the sub menu screen upon the corresponding main menu screen. (Such a display is referred to as multi-window display.) The display position on the CRT screen is fixed. It becomes impossible to input data temporarily onto the main menu screen that has been displayed in a multi-window format. The input prompt present on the main menu screen must be moved to the sub menu screen.

5.2 GET FUNCTIONS AND OPERATIONS

5.2.1 Ordinary GET Function and Operations

The GET function reads only the specified file, among the files associated with the main menu screen currently being displayed (see subsection 5.1.4) or details of the file attributes), and then displays the file contents to the main menu screen.

Press the GET key to display the sub menu screen on the CRT display so that a file name can be input. The main menu screen is dimmed (half-tone display) which means data cannot be input for now. Move the input prompt to the file-name menu item on the GET sub menu screen. Specify either disk drive F0 (built-in drive) or disk drive F1 (external drive) using the ENTRY key, and then input a file name and press the GET key once again. The GET operation will then be executed.

When the GET operation normally ends, the sub menu screen will disappear and the main menu screen will revert to its original display. Consequently, the data that has been read from the file will be displayed and it will become possible to input data for the menu items.

The file name (from "file name") in the center position of the top line indicates the source of the data appearing on the main menu screen. This file name remains on the screen until the displayed data has been overwritten by new data.

5.2.2 QuickGET Function and Operations

The ordinary GET function may cause significant operational burden on the user during input of file names. The TR4726 provides two operation methods that enable file names to be input indirectly without using the ENTRY key. One of these two methods is by using registered files (see subsection 5.1.4), and the other is by using the scroll knob. Both methods enable the GET function to be performed quickly, and are thus referred to collectively as the QuickGET function. The QuickGET function almost eliminates the necessity of the ordinary GET function.

Once a "registered" file has been actually registered, the registered file name will be displayed on the sub menu screen when the GET key is pressed. Pressing the GET key again makes it operate as an EXECUTE key. Therefore the contents of the registered file can be displayed on the main menu screen without keying in any file name. Because one "registered" file can be actually registered for each main menu screen, it is suggested that the files likely to be used most frequently be registered. The method for the scroll knob is a more general method.

TR4726
LOGIC ANALYZER
OPERATION MANUAL

5.2 GET FUNCTIONS AND OPERATIONS

Press the **GET** key to start the sub menu screen, and then turn the scroll into clockwise. This causes the file names within the disk to be displayed in sequence. Stop turning the knob when the desired file name is displayed, and press the **GET** key. That file will then be read and the contents displayed on the main menu screen. Using the directory display function together with the QuickGET function causes the file name in the top position on the directory display to be displayed in synchronization with the file name used for GET purposes.

5.3 SAVE FUNCTIONS AND OPERATIONS

5.3.1 Ordinary SAVE Function and Operations

The ordinary SAVE function is used to write the data of the main menu screen currently being displayed into the specified file. If the file having the specified file name is already inside the user disk, then the contents of that file will be erased by the new data. If the file is not yet stored within the user disk, a new file will be created automatically.

Press the **[SAVE]** key to display the sub menu screen so that a file name can be input. The main menu screen dims (half-tone display) which means data cannot be input for now. Move the input prompt to the file-name menu item on the **SAVE** sub menu screen. First, system-saved file names (see subsection 5.3.2) will be displayed. Further turning of the rotary knob (clockwise) will cause the file names within the disk to be displayed in sequence. Any desired file name can be selected simply by first specifying either disk drive F0 (built-in drive) or disk drive F1 (external drive) using the **ENTRY** key, and then typing in a file name. After naming a file, press the **[SAVE]** key once again. The file will then be saved. After this file is saved, the sub menu will disappear, the main menu screen will revert to its original status, and the main menu screen data will be written into the file.

The saved file name will be displayed on the main menu screen. Use the directory display function with this SAVE function to check the created files. However, be sure to first press the **[FD]** key twice to check the file name, and then press the **[SAVE]** key and carry out the operations mentioned above.

5.3.2 Quick SAVE Function and Operations

The ordinary SAVE function may cause significant operational burden on the user during input of file names. This method is okay, for files that have already been saved. However, for files that are not yet saved, especially in cases where large quantities of data (several files) are to be quickly acquired, it may be troublesome to carry out saving operations using only the ordinary SAVE function. The TR4726 provides an operation method that enables file names to be input indirectly without using the **ENTRY** key. Such a method uses registered files (see subsection 5.1.4). This method enables the SAVE function to be performed quickly, and is thus referred to as the QuickSAVE function.

Press the **[SAVE]** key to display a system-saved file name on the file-name menu item of the sub menu screen. The system-saved file number displayed will be "1" plus "the system-saved file number previously saved on the disk." Press the **[SAVE]** key once again makes it operate as an execution key.

TR4726
LOGIC ANALYZER
OPERATION MANUAL

5.3 SAVE FUNCTIONS AND OPERATIONS

Therefore the main menu screen data can be written into that system-saved file without in any file name. To name and then save a part of the "saved" system-saved file as a user file, first copy the desired system-saved file into a user file using the COPY function (see section 5.10), and then erase all the system-saved files using the PURGE function (see section 5.6). Note that the DELETE function cannot be used for erasing the system-saved files.

5.4 DIRECTORY FUNCTIONS AND OPERATIONS

5.4.1 DIRECTORY-of-MENU Function and Operations

The DIRECTORY-of-MENU function is used to list only files associated with the main menu screen currently displayed that are stored within a disk.

Press the **[FD]** key to display the FD sub menu screen on the right side of the CRT. It is then temporarily impossible to input data for the menu items. Move the input prompt to the command selection menu item of the sub menu screen. To perform the DIRECTORY-of-MENU operation specify either disk drive F0 (built-in drive) or disk drive F1 (auxiliary (external) drive) and then press the **[FD]** key once more.

Disk drive F0 will be automatically selected if a disk drive is not selected. Therefore, if the built-in disk drive is used, the directory of menus stored within the disk can be check simply by pressing the **[FD]** key twice.

5.4.2 DIRECTORY-of-ALL Function and Operations

The DIRECTORY-of-ALL function is used to list all files stored within a user disk.

Presss the **[FD]** key to display the **[FD]** sub menu screen on the right side of the CRT. It is then temporarily impossible to input data for the menu ites. Move the input prompt to the command selection menu item of the sub menu screen. Since the DIRECTORY-of-MENU has already been selected, change to DIRECTORY-of-ALL by pressing the **[◻]** **[NEXT]** (or **[PREV]**) keys. To perform the DIRECTORY-of-ALL operation specify either disk drive F0 (built-in drive) or disk drive F1 (auxiliary (external drive) first and then press the **[FD]** key once more. Disk drive F0 will be automatically selected in default of disk-drive selection.

The heading of the directory display means the following: "name" indicates the file name; "blks" (blocks) indicates the file size (1 block = 256B); "attri" indicates the file attribute (see subsection 5.1.4), and; "date" indicates the date and time when the file has been created.

Press the **[STOP]** key to erase the **[FD]** sub menu screen.

Pressing a key of the **[MENU]** key group also erases the FD sub menu screen. Press the **[GET]** or **[SAVE]** key to erase the sub menu screen after the GET or SAVE operation ends.

5.5 REGISTER FUNCTION AND OPERATIONS

The REGISTER function is used to create registered files (see subsection 5.1.4) that are controlled by the QuickGET function (see subsection 5.2.2).

One registered file can be created for each main menu screen. These files are created by registering a user or system-saved file (see subsection 5.1.4) with the REGISTER function.

This function can also be used for checking the original of a registered file that has already been "registered".

If a system-saved file has been registered as a registered file, system-saved file names that have been updated when the PURGE function was executed. In addition, if the original of a registered file is deleted, it will no longer be possible to check which of the files is the original. The role of the registered file itself, however, will still remain unchanged.

Press the **[FD]** key to display the **FD** sub menu screen on the right side of the CRT. It is then temporarily impossible to input data for the menu items. Move the input prompt to the command selection menu item of the sub menu screen. Since the DIRECTORY-of-MENU command has already been selected, change this command must be to REGISTER by pressing the **[NEXT]** key. To perform the registration operation specify the original file name used for registration and specify either disk drive F0 (built-in drive) or disk drive F1 (auxiliary (external) drive). Then press the **[FD]** key once more.

If you want to check the original file name of a registered file, that file name can be displayed only by selecting the REGISTER command.

Press the **[STOP]** key to erase the **FD** sub menu screen. The **FD** sub menu screen can also be erased by pressing a key of the **MENU** key group. Press the **[GET]** or **[SAVE]** key erase the sub menu screen after the GET or SAVE operation ends.

5.6 PURGE FUNCTION AND OPERATIONS

The PURGE function is used to erase all system-saved files (see subsection 5.1.4) that are created using the QuickSAVE function (see subsection 5.3.2).

General files (user files) are to be erased using the DELETE function (see section 5.7). However, since system-saved files are managed collectively by the TR4726, these files should be erased (if necessary) using this PURGE function in order to maintain their consistency. The specified number of files are erased collectively in the order that they have been created. If the series of system-saved files that are no longer necessary include those which are to remain saved, execute the PURGE function only after copying the contents of those files into a user file using the COPY function (see section 5.10).

Press the **[FD]** key displays the **FD** sub menu screen on the right side of the CRT. It is then temporarily impossible to input data for the menu items. Move the input prompt to the command selection menu item of the sub menu screen. Since the DIRECTORY-of-MENU command has already been selected, changed this command to PURGE by pressing the **[NEXT]** key twice.

Before erasing a file, check the file name in advance using the directory display function. To do so, first execute the DIRECTORY-of-MENU function (see subsection 5.4.1) and then press the **[NEXT]** key twice to change that function to PURGE. Note, however, that if the built-in drive is used, the **[FD]** key must be pressed not once but twice when executing the DIRECTORY-of-MENU function. If an auxiliary (external) drive is to used, drive F1 must be specified before pressing the **[FD]** key for the second time.

Next, press the **[C]** key twice to move the input prompt to the NUMBER OF DELETED FILE menu item, and then press the **[NEXT]** or **[PREV]** key to set the number of files to be erased. The number of files to be erased is preset to 0 initially. Each time the **[NEXT]** key is pressed the number of files increase by one. Pressing the **[FD]** key with the number of files remaining preset to 0 will display the maximum number of files that can be erased. To start erasing press the **[FD]** key after setting the number of files. After erasing, the results will be displayed on the screen as the directory screen.)

The oldest file (having the ".S1" extender) is erased first. Files remaining unerased will have their extender numbers reduced according to the erased number of files.

This extender will be changed after the system-saved files are set as registered files.

Note that the PURGE function will not work if the disk is placed in a write-protected status (see subsection 5.1.2).

TR4726
LOGIC ANALYZER
OPERATION MANUAL

5.6 PURGE FUNCTION AND OPERATIONS

Press the **STOP** key to erase the FD sub menu screen. The **FD** sub menu can also be erased by pressing a key of the **MENU** key group. Press the **GET** or **SAVE** key to erase the sub menu screen after completing the GET or SAVE operation.

5.7 DELETE FUNCTION AND OPERATIONS

The DELETE function erases user files (see subsection 5.1.4). File are erased by specifying one file name each time. The wild cards of file names are not supported by this function.

Use the PURGE function (see section 5.6), not the DELETE function, to erase system-saved files (see subsection 5.1.4).

Press the **[FD]** key displays the **FD** sub menu screen on the right side of the CRT. It is then temporarily impossible to input data for the menu items. Move the input prompt to the command selection menu item of the sub menu screen. Since the DIRECTORY-of-MENU command has already been selected, change this command to DELETE by pressing the **[NEXT]** key three times.

Before deleting a file, it is advisable to check the file name in advance using the directory display function. In you have done the preceding step, first execute the DIRECTORY-of-MENU function (see subsection 5.4.1) and then press the **[NEXT]** key three times to change that function to DELETE. Note, however, that if the built-in drive is used, the **[FD]** key must be pressed twice when executing the DIRECTORY-of-MENU function. If an auxiliary (external) drive is used, drive F1 must be specified before pressing the **[FD]** key for the second time.

Next, move the input prompt to the file-name input menu item using the **[↵]** key, and then input a file name using a key of the **ENTRY** key group.

After a file name has been input, press the **[FD]** key to delete the file. After the file has been deleted, the results will be displayed on the directory screen.

Note that the DELETE function will not work if the disk is placed in a write-protected status (see subsection 5.1.2).

Press the **[STOP]** key to erase the FD sub menu screen.

The **FD** sub menu screen can also be erased by pressing a key of the **MENU** key group. Press the **[GET]** or **[SAVE]** key to erase the sub menu screen after completing the GET or SAVE operation.

TR4726
LOGIC ANALYZER
OPERATION MANUAL

5.8 FORMAT FUNCTION AND OPERATIONS

5.8 FORMAT FUNCTION AND OPERATIONS

The FORMAT function creates a user disk (see Section 5.1.3). When a floppy disk (blank disk) is purchased, it cannot be used in this system. The disk must be formatted so that data can be written on it. When a blank disk is formatted, it is called the user disk. The capacity of blank disk (unformatted disk) is 1M bytes but the capacity of user disk (formatted disk) is 632.5K bytes. (1K bytes is equal to 1024 bytes).

The user disks created by the FORMAT function can be identified by the disk ID and description. The disk ID has the standard format of the system disk which has created the user disk. For example, if a user disk is created by the system disk having the disk ID of "TR47250 SYSTEM DISK", this user disk has its disk ID of "TR47250 USER DISK". If the system disk and user disk have different disk IDs, data cannot be transferred between them.

For the description, the user can specify any desired character string of up to 20 alphanumeric characters to identify each user disk.

When the FD key is pressed, the "FD" submenu is displayed at the right of the screen. The main menu will change to the half-tone screen and data entry will be halted temporarily. The prompt will move to the menu item on the menu screen for command selection. The "DIRECTORY-of-MENU" command is currently selected on the screen. Press the NEXT or PREV key four times in succession to select the "FORMAT" command (see Figure 5-25).

Then, press the key to shift the prompt to the DRIVE or DESCRIPTION menu item. By selecting the DRIVE menu item, specify the drive ("F0:" is the default built-in drive and "F1:" is the auxiliary drive). By selecting the DESCRIPTION menu item, enter the disk identification name and press the ENTRY key. The disk name will be written on the disk. It can be displayed on the screen any time by using the "STATUS-of-DISK" function (see Section 5.11.2). An input example is given in Figure 5-26.

Press the FD key, and the disk formatting will start (see Figure 5-27). As an incorrect operation of the FORMAT function may erase all necessary files, the verification message is displayed before the disk is formatted. If you agree to format the disk, respond with "Y" (by pressing the blue SHIFT and keys simultaneously).

The system disk and write-protected user disks cannot be formatted.

When formatting is complete, the status information of the created user disk is displayed on the screen (see Figure 5-28). The display format of this information is the same as that of the "STATUS-of-DISK" function. The available disk area is 2530 blocks or 632.5K bytes as a single block is equal to 256 bytes.

To delete the "FD" submenu, press the STOP key. It can also be erased by pressing the MENU group key. When the GET/SAVE key is pressed, the submenu is erased after disk formatting.

5.9 RENAME FUNCTION AND OPERATIONS

The RENAME function renames the user files (see subsection 5.1.4) that have been created by the user. Neither system-saved files nor registered files can be renamed with this function. Use the COPY function (see section 5.10) to create files having the same contents as those of system-saved files or registered files.

Pressing the **[FD]** key to display the **FD** sub menu screen on the right side of the CRT. It is then temporarily impossible to input data for the menu items. Move the input prompt to the command selection menu item of the sub menu screen. Since the DIRECTORY-of-MENU command has already been selected, change this command to RENAME by pressing the **[PREV]** key three times.

Before renaming a file, it is advisable to check the file name in advance using the directory display function. In that case, first execute the DIRECTORY-of-MENU function (see subsection 5.4.1) and then press the **[PREV]** key three times to change that function to RENAME. Note, however, that if the built-in drive is used, the **[FD]** key must be pressed twice when executing the DIRECTORY-of-MENU function. If an auxiliary (external) drive is used, drive F1 must be specified before pressing the **[FD]** key for the second time.

Move the input prompt to the file-name input menu item using the **[↔]** key, and then input the current and new file names using a key of the **ENTRY** key group. (Input the current file name to the OLD NAME column, and input a new file name to the NEW NAME column.)

After the file names have been input, press the **[FD]** key to start renaming the files. After the renaming the files, the results will be displayed on the directory screen.

Note that the RENAME function will not work if the disk is placed in a write-protected status (see subsection 5.1.2).

Press the **[STOP]** key to erase the **FD** sub menu display.

The **FD** sub menu screen can also be erased by pressing a key of the **MENU** key group. Press the **[GET]** or **[SAVE]** key to erase the sub menu screen after completing the GET or SAVE operation.

5.10 COPY FUNCTION AND OPERATIONS

The COPY function copies the contents of one file to another file. This function is used to back up the measuring conditions, measured data, or other files which have already been created.

The file containing the data to be copied is referred to as the source file. The file which the data is to be copied to is referred to as the destination file. If the file that has been specified as the destination file is already stored within the disk, then the previous data will be erased and new data will be stored into that file.

If the file that has been specified as the destination file is not yet stored within the disk, then a new file will be created and data written into that file.

Any user file can be specified at either the source or the destination source. The desired system-saved file or registered file can be specified as the source file, but it cannot be specified as the destination file.

Figure 5-2 shows the File combinations that can be made using the COPY function.

Press the **[FD]** key to display the **FD** sub menu screen on the right side of the CRT. It is then temporarily impossible to input data for the menu items. Move the input prompt to the command selection menu item of the sub menu screen. Since the **DIRECTORY-of-MENU** command has already been selected, change this command to **COPY** by pressing the **[PREV]** key twice.

Before copying a file, it is advisable to check the file name in advance using the directory display function. In that case, first execute the **DIRECTORY-of-MENU** function (see subsection 5.4.1) and then press the **[PREV]** key twice to change that function to **COPY**. Note, however, that if the built-in drive is used, the **[FD]** key must be pressed twice when executing the **DIRECTORY-of-MENU** function. If an auxiliary (external) drive is used, drive **F1** must be specified before pressing the **[FD]** key for the second time.

In the directory display, data can be scrolled only when the scroll mark is on the bottom line of the **FD** menu screen. (The scroll mark in this position indicates that eight or more files are present.)

Next, move the input prompt to the file-name input menu item using the **[C]** key, and then input file names using a key of the **ENTRY** key group. (The name of the file to be specified as the source file must be input to the **FROM** column, and the name of the file to be specified as the destination file must be input to the **TO** column.)

After file names have been input, press the **[FD]** key to start the copying. After copying is completed, the results will be displayed the directory screen.

5.10 COPY FUNCTION AND OPERATIONS

Note that the COPY function will not work if the disk is placed in a write-protected status (see subsection 5.1.2).

Press the **STOP** key to erase the **FD** sub menu screen. The **FD** sub menu screen can also be erased by pressing a key of the **MENU** key group. Press the **GET** or **SAVE** key to erase the sub menu screen after completing the **GET** or **SAVE** operation.

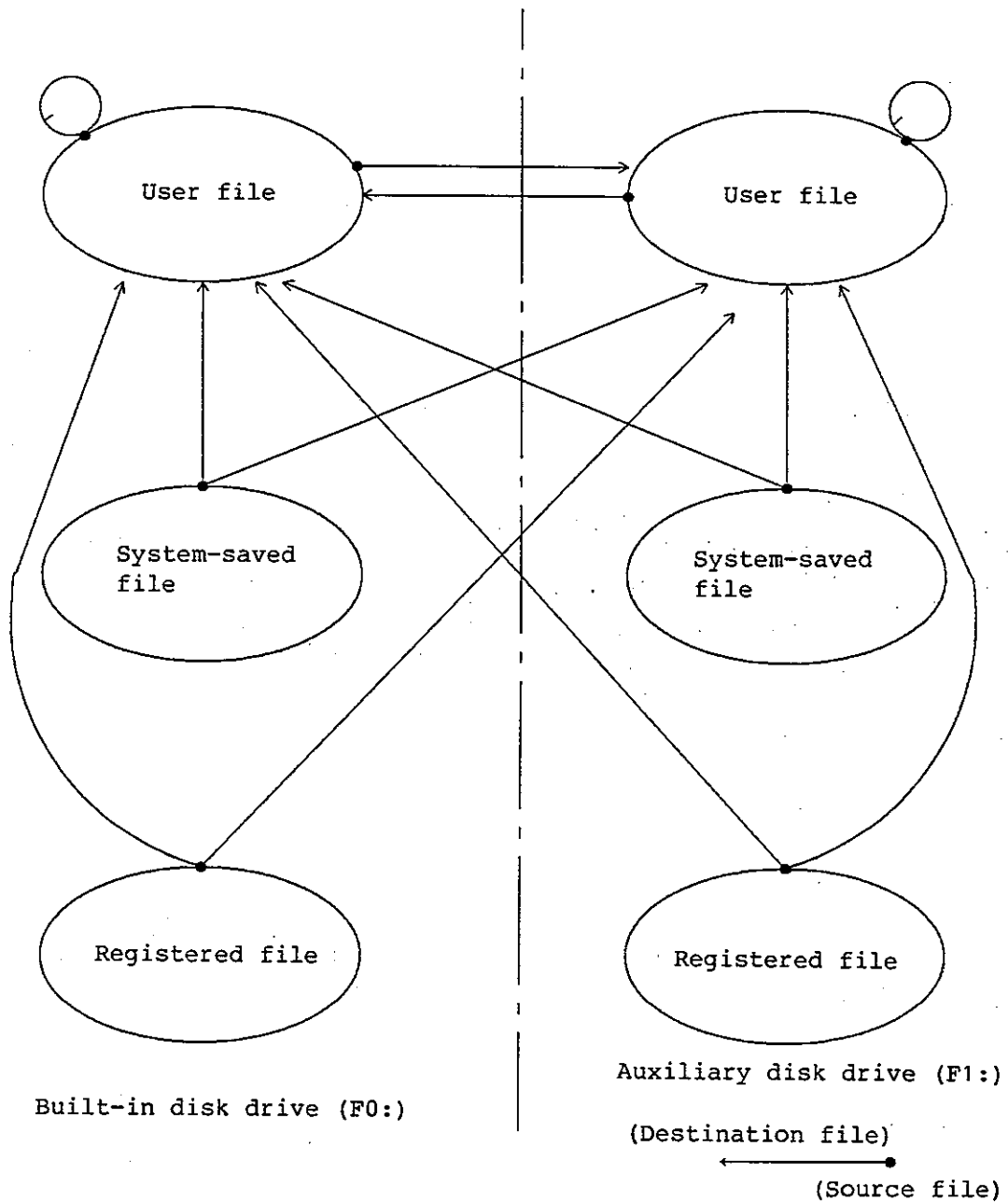

Figure 5-2 COPY Function and Files

5.11 STATUS FUNCTIONS AND OPERATIONS

5.11.1 STATUS-of-FILES Function and Operations

The STATUS-of-FILES function displays the operational status of files (see subsection 5.1.4 for details of file attributes) that are related to the main menu screen currently displayed.

The total number and size of registered files, system-saved files, and user files are displayed.

Press the **[FD]** key to display the **FD** sub menu screen on the right side of the CRT. It is then temporarily impossible to input data for the menu items. Move the input prompt to the command selection menu item of the sub menu screen. Since the DIRECTORY-of-MENU command has already been selected, change this command to STATUS-of-FILES by pressing the **[PREV]** key. Next, move the input prompt to the DRIVE menu item using the **[↵]** key. Specify either disk drive F0 (built-in drive) or disk drive F1 (auxiliary (external) drive), and press the **[FD]** key once more. This will initiate the STATUS-of-FILES operation.

The file size is displayed in block units. (1 block = 256B)

Press the **[STOP]** key to erase the FD sub menu screen. Then **FD** sub menu screen can also be erased by pressing a key of the **MENU** key group. Press the **[GET]** or **[SAVE]** key to erase the sub menu screen after completing the GET or SAVE operation.

5.11.2 STATUS-of-DISK Function and Operations

The STATUS-of-DISK function displays disk identification information and the operational status of the disk.

Pressing the **[FD]** key to display the **FD** sub menu screen on the right side of the CRT. It is then temporarily impossible to input data for the menu items. Move the input prompt to the command selection menu item of the sub menu screen. Since the DIRECTORY-of-MENU command has already been selected, change this command to STATUS-of-DISK by pressing the **[PREV]**, **[↵]**, and **[NEXT]** keys, in that order. Next, move the input prompt to the DRIVE menu item using the **[↵]** key and specify either disk drive F0 (built-in drive) or disk drive F1 (auxiliary (external) drive). Then press the **[FD]** key once more. This will initiate the STATUS-of-DISK operation.

For user disks, the screen contents mean the following:

The data in the DISK ID column has been written forcibly during formatting, and the personality kits available for that particular data disk are determined in a unique manner by the system disk that was used at that time. (This ensures that data for different personality kits are not mixed on a single user disk.)

TR4726
LOGIC ANALYZER
OPERATION MANUAL

5.11 STATUS FUNCTIONS AND OPERATIONS

The data in the DESCRIPTION column, which has also been written during formatting, can be used for disk management.

The operational status of the disk is displayed in the order of AVAILABLE AREA USED AREA BAD AREA. (1 block = 256B)
BAD AREA refers to the area on the disk that is unavailable because it is flawed or damaged in same way. Such a bad area is skipped during file system operation.

Press the STOP key to erase the FD sub menu screen. The FD sub menu screen can also be erased by pressing a key of the MENU key group. Press the GET or SAVE key to erase the sub menu screen after completing the GET or SAVE operation.

TR4726
LOGIC ANALYZER
OPERATION MANUAL

6. PROGRAM PREPARATION AND EXECUTION (PROGRAM/AUTO)

TABLE OF CONTENTS

6. PROGRAM PREPARATION AND EXECUTION (PROGRAM/AUTO) 6 - 3

TR4726
LOGIC ANALYZER
OPERATION MANUAL

6. PROGRAM PREPARATION AND EXECUTION (PROGRAM/AUTO)

6. PROGRAM PREPARATION AND EXECUTION (PROGRAM/AUTO)

The PROGRAM/AUTO function of the TR4726 is not provided this current software version. Therefore, no description of this function is given in this section. This section will be described as soon as the PROGRAM/AUTO function is provided.

MEMO



A large, empty rectangular area with rounded corners, enclosed by a thin black border, intended for writing the memo's content.

TR4726
LOGIC ANALYZER
OPERATION MANUAL

7. SERIAL COMMUNICATIONS FUNCTIONS AND OPERATIONS (COMM)

TABLE OF CONTENTS

7. SERIAL COMMUNICATIONS FUNCTIONS AND OPERATIONS (COMM)	7 - 3
7.1 OUTLINE	7 - 3
7.2 EXECUTION OF REMOTE CONTROL	7 - 4
7.3 REMOTE CONTROL PROTOCOLS	7 - 5
7.4 REMOTE CONTROL COMMANDS	7 - 9

TR4726
LOGIC ANALYZER
OPERATION MANUAL

7.1 OUTLINE

7. SERIAL COMMUNICATIONS FUNCTIONS AND OPERATIONS (COMM)

7.1 OUTLINE

The TR4726 can serially communicate with external computer systems (hereinafter referred to as host computers) or terminal devices via the RS-232C interface located on the rear panel.

The COMM sub menu can be displayed on all main menus, except the UTILITY menu.

For details of the communications mode and parameter setting procedures, refer to section 8.3, "Communications (RS-232C) Parameter Setting."

TR4726
LOGIC ANALYZER
OPERATION MANUAL

7.2 EXECUTION OF REMOTE CONTROL

7.2 EXECUTION OF REMOTE CONTROL

This section describes the procedure for placing the TR4726 in the remote control mode. First, change the initial display of the TR4726 to a menu screen other than the UTILITY menu screen and press the COMM key. The COMM sub menu shown in Figure 7-1, will then be displayed. Press the COMM key once more to set the TR4726 in the remote control mode. Commands can be now input from a host computer. Start the control program of the host computer. Send the command specified by the appropriate protocol to remote control. Once the TR4726 has been placed in the remote control mode, only the STOP key can be pressed.

Remote control can be terminated using the EN command (see Figure 7-2) that is usually sent from a host computer, but it can also be forcibly interrupted using the STOP key (see Figure 7-3). If the STOP key is pressed, "REMOTE: Aborted!" will be displayed and the remote control mode is released.

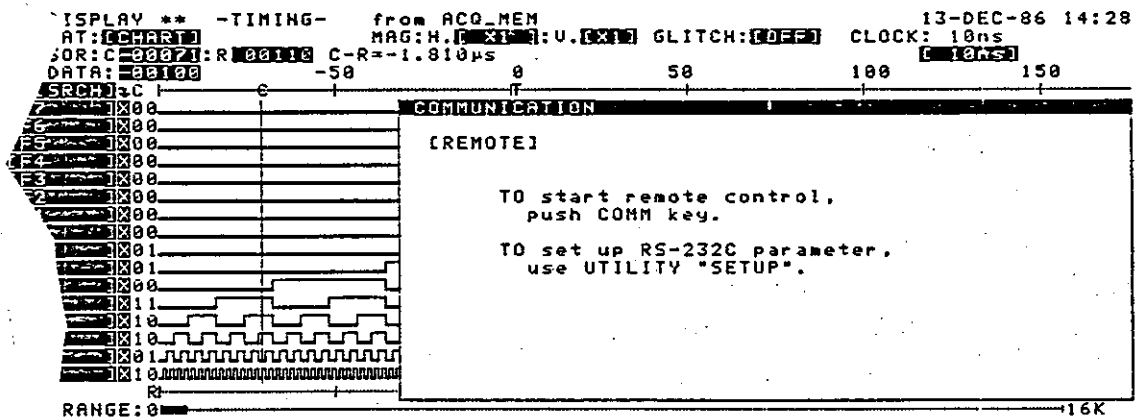

Figure 7-1 COMM Menu Screen

TR4726
LOGIC ANALYZER
OPERATION MANUAL

7.3 REMOTE CONTROL PROTOCOLS

7.3 REMOTE CONTROL PROTOCOLS

Protocols refer to the rules that the TR4726 must follow during interactive communications with host computers. To execute remote control accurately, programs that satisfy the protocols (such programs are referred to as remote control programs) must be prepared and executed by the host computers.

Three different protocols are provided: a normal sequence, a forced-interruption sequence, and a time-out sequence.

(1) Normal sequence

In the normal sequence, commands and command responses alternate as shown in Figure 7-2.

The following describes the normal sequence together with associated operations.

- ① When the COMM key is pressed once more, the TR4726 will enter the remote control mode and will no longer become operable from the keyboard located on the front panel. (This state is equivalent to the online status of terminal devices and other external units.)
- ② The appropriate remote-control program is to be started by the host computer. Under remote control programs, a dummy delimiter (@) must be issued first.
- ③ The TR4726 sends R@ in response to this delimiter.
(R indicates that the TR4726 is ready for receiving a command.)
- ④ A command is issued from the host computer.
- ⑤ The TR4726 receives the command and then executes it.
After that, the TR4726 reports one of anyone of R@, E@, and T@. If the command is the data-transfer request command (DS/DT command), then one of the above three delimiters will be issued after completing the data transfer.
- ⑥ Steps ④ and ⑤ are to be repeated as often as necessary to execute remote control.
- ⑦ The EN@ command is sent from the host computer to a normally end the sequence come to.
- ⑧ When the TR4726 receives EN@, it will send R@ to the host computer and release the remote control mode.

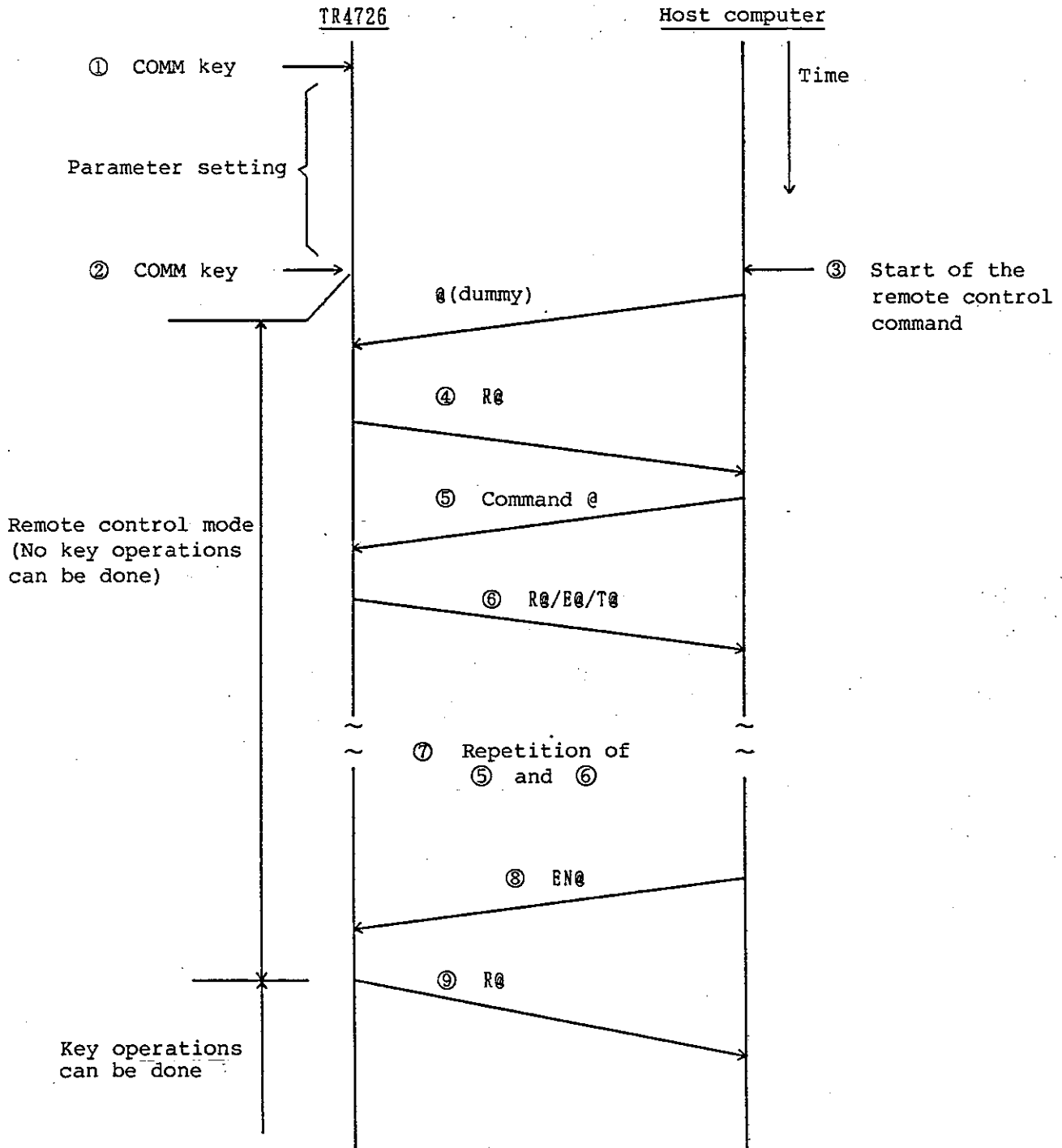

Figure 7-2 Normal Sequence

TR4726
LOGIC ANALYZER
OPERATION MANUAL

7.3 REMOTE CONTROL PROTOCOLS

(2) Forced-interruption sequence

The forced-interruption sequence shown in Figure 7-3 will be set when the normal sequence in progress is aborted by pressing of the STOP key (the TR4726 side).

- ① When the STOP key is pressed during the execution of normal sequence, !@!@ will be send to the host computer and the remote control mode will be released.
- ② The host computer must then perform the appropriate processing operation for the forced-interruption.

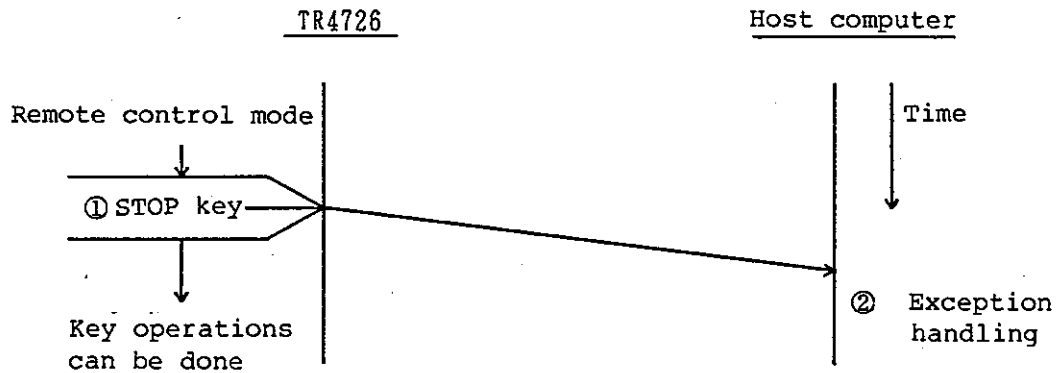

Figure 7-3 Forced-Interruption Sequence

(3) Time-out sequence

If during the normal sequence communications are interrupted because of line or host computer faults, then the time-out sequence shown in Figure 7-4 will be set after a fixed time and the TR4726 will interrupt the communications.

- ① If during the execution of the normal sequence no delimiters are detected within five seconds after receiving a part of commands from the host computer, then !@!@ will be sent to the host computer and the remote control mode will be released.
- ② The host computer must then perform the processing operation appropriate for the forced-interruption.

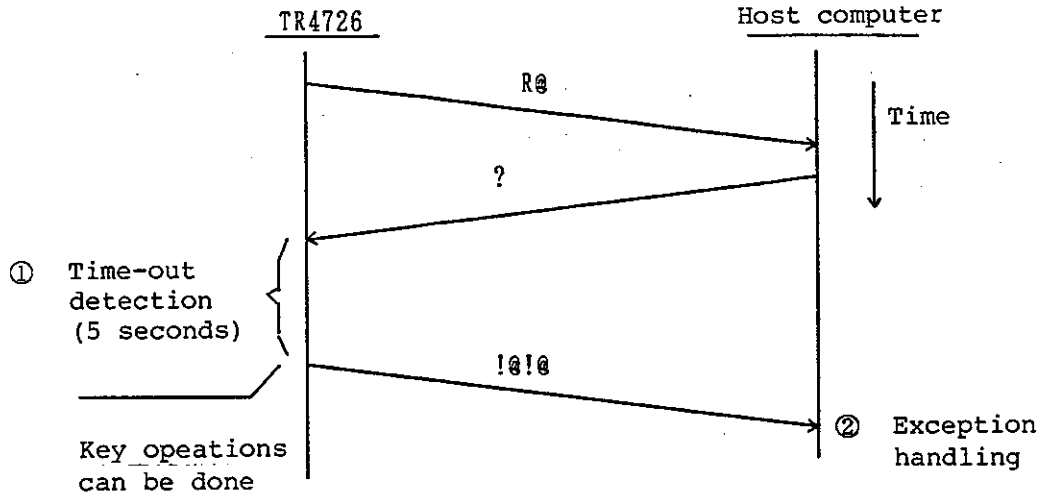

Figure 7-4 Time-Out Sequence

TR4726
LOGIC ANALYZER
OPERATION MANUAL

7.4 REMOTE CONTROL COMMANDS

7.4 REMOTE CONTROL COMMANDS

Remote control commands (hereinafter referred to as commands) are sent from the host computer to the TR4726 in order to externally control of the TR4726.

Two types of commands are sent: data transfer commands and menu-related commands. The commands follow the rules given below:

- . Commands are issued in either uppercase or lowercase ASCII code.
(Enclosed in ",".)
 - . Commands and their respective arguments are each separated by more than one blank. (Expressed by __.)
 - . Each command ends with a delimiter (@).
 - . The codes in arguments have the following meaning:
 - b: One binary digit (Don't care "X" included)
 - d: One decimal digit
 - h: One hexadecimal digit
 - file: File name (6 characters, maximum)
 - ext: Extension of the file (3 characters, maximum)
 - +/-: + or -
 - U: Units
 - Enclosed in { } : Option
- (All the above are in ASCII code.)
- . For decimal numbers, the preceding 0s and + signs can be omitted.

(1) Data transfer commands

① DS command

After receiving this command, the TR4726 transfers the measured data stored within the ACQ_MEM of the state analyzer to the host computer. In default, only the necessary data will be transferred to the host computer if all data stored within ACQ_MEM is specified using the RS command (see ② below).

Format: "DS"@

② RS command

The range of data transferred using the DS command is to be specified by two line numbers. The two line numbers must take decimal values from 0000 to 1023, with the value of the first line number being smaller than or equal to that of the second line number. If no data is present within the specified range, then the specification will be ignored.

Format : "RS_ddd,ddd"@

Example: "RS_0000,0099"@ --- To be specified so that the first 100 lines of data are transferred.

③ DT command

After receiving this command, the TR4726 transfers the measured data stored within the ACQ_MEM of the state analyzer to the host computer. In default, only the necessary data will be transferred to the host computer if all data (other than glitch data) stored within ACQ_MEM is specified using the RT command (see ④ below).

Format: "DT"@

④ RT command

The range of data transferred using the DT command is to be specified by the channel number and the memory range. The channel number must be specified by setting PRB_F7 (probe F, channel 7) as MBS (most-significant bit), setting the desired channel to a binary 1, and setting the undesired channel to a binary 0. The transfer memory range (dddd,dddd) must be specified by setting the transfer starting and ending positions to five decimal digits (0000 to 65,519). In addition, transfer control of glitch can be sent not using g=0 but using g=1. In default, it is recognized as g=0.

Format: "RT_{g:} hhhh:dddd,dddd"@

(2) Menu-related commands

① CO command

After receiving this command, the TR4726 displays the CONFIG menu screen.

Format: "CO"@

② TR command

After receiving this command, the TR4726 displays the TRACE menu screen.

Format: "TR"@

③ SY command

After receiving this command, the TR4726 displays SYMDEF menu screen.

Format: "SY"@

- ④ DI command
After receiving this command, the TR4726 displays the DISPLAY menu screen.

Format: "DI"@

- ⑤ GE command
After receiving this command, the TR4726 GETs data from the specified file within the disk inserted into built-in drive F0 or auxiliary (external) drive F1. The default value of drive specification is F0:.

Format: "GE_{Fb:} file.ext"@

- ⑥ SQ command
After receiving this commands, the TR4726 QuickSAVES data into a system-saved file within the disk inserted into F0: or F1:.. The default value of drlve specification is F0:.

Format: "SQ_{Fb:} "@

- ⑦ SA command
After receiving this command, the TR4726 SAVES data into a system-saved file within the disk inserted into F0: or F1:.. The default value of drive specification is F0:.

Format: "SA_{Fb:} file.ext"@

- ⑧ RU command
After receiving this command, the TR4726 starts measurement. If measurement does not end even after the lapse of the specified time since the beginning of the measurement process, then "T"@ (time-out) will be sent from the TR4726 and the measurement process will be aborted. The value of ddd specified must be a value from 1 to 255, and U must be specified in the S (second)/M (minute)/H (hour) format. The default value is 255 s (4 minutes, 16 seconds).

Format: "RU_{dddU} "@

(3) Data transfer from the ACQ_MEM of the timing analyzer

Data is transferred using the DT or RT command in the following formats:

Format: "%"	"size of data to be transferred", "transfer starting position", "transfer ending position", "trigger position", "No. of transfer channels", "clock", "whether or not to transfer glitch data" @
"#"	"channel No.", "presence/absence of data to be transferred", "block size of data to be transferred", "No. of blocks of data to be transferred" @

TR4726
LOGIC ANALYZER
OPERATION MANUAL

7.4 REMOTE CONTROL COMMANDS

"Data to be transferred" @ --- "Data to be transferred" @ "&",
"check data" @
(Repeated for each of the 16 channels.)

If glitch data is to be transferred, "#" will become "*" but the format will remain the same. Glitch data will be transferred only after 16 channels or 8 channels of data have been transferred, depending on the number of transfer channels used.

"size of data to be transferred": 5 decimal digits (up to 65,520)
(Magnitude in the time-base direction)
(No. of samples)

"transfer starting position" : 5 decimal digits

"transfer ending position" : 5 decimal digits

"trigger position" : "+/-", 5 decimal digits. The position of the trigger existing after the oldest data has been set as "0000". "?????" (irrespective of the trigger position) if the data is one existing after forced-interruption.

"No. of transfer channels" : No. of ACQ channels "_8CH" or "16CH".

"clock" : 5 characters to indicate the sampling clock.
(Example: "_10ns", "3.3ns")

"whether or not to transfer glitch data" : 1 character A for transfer, N for no transfer.

"channel No." : 2 characters to indicate a specific channel name (such as F7). 16 channel numbers are transferred even if there is no data to be transferred.

"presence/absence of data to be transferred" : 1 character A if present, N if absent.
(As per the RT command)

"block size of data to be transferred" : 3 decimal digits to indicate the number of blocks into which one channel of data is to be divided. (Default: 064)

"No. of blocks of data to be transferred" : 1 decimal digit to indicate the number of transfer blocks per channel.
(For 64K data transfer, up to 256B)

TR4726
LOGIC ANALYZER
OPERATION MANUAL

7.4 REMOTE CONTROL COMMANDS

- "data to be transferred" : A maximum of 64 hexadecimal digits of data itself. (Every four bits of old data are integrated into one hexadecimal digit.) In the transfer block data is insufficient data will be sent in ASCII code "-" if the number of bits wanting is four or more: if it is less than four, data will be sent up to the required block size after it has been filled in by a binary 0.
- "check data" : 3 decimal digits. The sum of "1", "3", and "7" is included in the data to be transferred. It can be used for transfer check purposes.

NOTE

- 1: After receiving the DS or DT command, the TR4726 sends the dummy @. Data transfer will start when the host computer receives the dummy @ and then sends R@ in return. The host computer must send R@ in return each time the data delimiter (@) comes.
- 2: Once B@ has been returned from the host computer, it becomes possible to nullify the effects of the DS or DT command during data transfer.

(4) Status reports

- ① Ready for command issuance (Ready)
This status report informs the host computer that the preceding command has normally ended and that the TR4726 has become ready for receiving the next command.
Format: "R"@
- ② Error occurring (Error)
This status report informs the host computer that an error has occurred within the TR4726.
Format: "E"@
- ③ Time-out
This status report informs the host computer that the specified time is out within the TR4726.
Format: "T"@
- ④ Forced-interrupt occurring (Abort)
This status report informs the host computer that the normal sequence is to be aborted within the TR4726 by establishing the forced-interruption sequence or the time-out sequence.
Format: "!"@

MEMO



A large, empty rectangular box with rounded corners, intended for writing the memo's content.

TR4726
LOGIC ANALYZER
OPERATION MANUAL

8. UTILITY FUNCTION AND OPERATIONS

TABLE OF CONTENTS

8. UTILITY FUNCTION AND OPERATIONS	8 - 3
8.1 UTILITY COMMAND LOADING	8 - 3
8.2 CALENDAR CLOCK SETTING	8 - 4
8.3 COMMUNICATIONS (RS-232C) PARAMETER SETTING	8 - 5
8.4 SETTING THE DISK DRIVE	8 - 7
8.5 FLOPPY DISK FORMATTING AND INITIALIZATION	8 - 8
8.6 DISK COPY	8 - 10

TR4726
LOGIC ANALYZER
OPERATION MANUAL

8.1 UTILITY COMMAND LOADING

8. UTILITY FUNCTION AND OPERATIONS

8.1 UTILITY COMMAND LOADING

The utility function, which consists of several utility commands, provides various types of services not directly related to measurement.

Unlike the programs that control the other parts of the TR4726, utility commands are loaded from the system disk and executed each time they are used. That is, utility commands are "transient commands". When the UTILITY key is pressed, the UTILITY screen (Figure 8-1) is displayed. Next, when a command is selected using the EDIT key or the rotary knob (the prompt is moved to the designation number of the command to be executed) and then the RUN key is pressed, the program that contains the specified command will be loaded from the system disk.

Note that the keys available with the UTILITY function are only those of the MENU key group, in addition to the above. If the correct system disk has not yet been inserted into the built-in drive (F0:) when the RUN key is pressed, then the program will not be loaded. If that is the case, insert the correct system disk into the drive and then press the RUN key once more.

```
** UTILITY **           F0: UTILITY ONLY           03-DEC-86 19:01
Please select a UTILITY, and push RUN key to execute
(If you enter the other disk, push UTILITY key again)
  **DSKCPY.EXE
  **FORMAT.EXE
  **SETUP.EXE
```

KNOB EDIT↔

Figure 8-1 UTILITY Menu Screen

TR4726
 LOGIC ANALYZER
 OPERATION MANUAL

8.2 CALENDAR CLOCK SETTING

8.2 CALENDAR CLOCK SETTING

The TR4726 has a built-in calendar clock that is backed up by Ni-Cd batteries. The date and time is set using the UTILITY menu screen.

On the UTILITY menu screen, select the SETUP.EXE command and then press the RUN key to load the program. The screen shown in Figure 8-2 is displayed to enable clock time and communications parameter setting.

Set the date (year/month/day) and time using the SELECT key or the rotary knob. Next, press the RUN key to set the clock to that value and to display on the right side at the top of the CRT screen. Press the STOP key to return the display to the UTILITY menu screen. In addition, pressing keys of the MENU key group will display their specific menu screens.

While the POWER switch on the TR4726 remains set to the ON position, the Ni-Cd batteries are recharged continually. The clock will work for more than two weeks, provided that the batteries are fully charged.

```

** SET-UP **                                     03-DEC-86 19:08

REAL TIME CLOCK                                DISK DRIVE
  [03]-[0EC]-[86] [19]:[05]                 EXTERNAL DISK DRIVE [VES]
  (PUSH RUN KEY TO START)                  DEFAULT DISK DRIVE [F0]

RS-232C PORT CONFIGURATION
CONNECTION      [DCE] (HOST)
BAUD RATE      [9600] BPS
WORD LENGTH    [8] BITS
STOP BIT(S)    [1]
PARITY         [NONE]
TX DELIMITER   [CR+LF]
RX DELIMITER   [CR+LF]
HAND-SHAKE     [NONE]

                                           KNOB EDIT↔
    
```

Figure 8-2 SETUP Menu Screen

8.3 COMMUNICATIONS (RS-232C) PARAMETER SETTING

8.3 COMMUNICATIONS (RS-232C) PARAMETER SETTING

On the UTILITY menu screen, select the SETUP.EXE command. Press the RUN key to load the program. The screen shown in Figure 8-3 is displayed to enable clock time and communications parameter setting.

- ① CONNECTION
This parameter specifies the form of connection. Select either [DCE] (HOST) or [DET] (TERMINAL).
- ② BAUD RATE
This parameter specifies the baud rate. Select one from among 50, 55, 75, 110, 134.5, 150, 300, 600, 1200, 1800, 2400, 3600, 4800, 7200, 9600, and 19200 BPS (bits per second).
- ③ WORD LENGTH
This parameter specifies the word length. Select either 7 bits or 8 bits.
- ④ STOP BIT(S)
This parameter specifies the number of stop bits. Select either 1 bit or 2 bits.
- ⑤ PARITY
This parameter specifies a parity check mode. Select either [NONE], [EVEN], or [ODD].
- ⑥ TX DELIMITER
This parameter specifies a delimiter for the transmitting end. Select either [CR+LF], [CR], or [LF].
- ⑦ RX DELIMITER
This parameter specifies a delimiter for the receiving end. Select either [CR+LF], [CR] or [LF].
- ⑧ HAND-SHAKE
This parameter specifies a hand-shaking mode. Select either [NONE] or [X ON/X OFF].

Press the STOP key to return to the UTILITY menu. Pressing keys of the MENU key group will display their specific menu screens.

TR4726
LOGIC ANALYZER
OPERATION MANUAL

8.3 COMMUNICATIONS (RS-232C) PARAMETER SETTING

** SET-UP **

19-NOV-86 11:08

[19]-[NOV]-[86] [11]:[07]	
<PUSH RUN KEY TO START>	

EXTERNAL DISK DRIVE	[YES]
DEFAULT DISK DRIVE	[F0]

① CONNECTION	[EDGE] (HOST)
② BAUD RATE	[9600] BPS
③ WORD LENGTH	[8] BITS
④ STOP BIT(S)	[1]
⑤ PARITY	[NONE]
⑥ TX DELIMITER	[NONE]
⑦ RX DELIMITER	[NONE]
⑧ HAND-SHAKE	[NONE]

EDIT↔

Figure 8-3 SETUP Menu Screen (for RS-232C Parameter Setting)

Use the SELECT key or rotary knob to set the above parameters.

8.4 SETTING THE DISK DRIVE

On the UTILITY menu screen, select the SETUP.EXE command. Press the RUN key to load the program. The screen shown in Figure 8-4 is displayed to enable specification of the presence/absence of an external floppy disk drive and default disk-drive selection.

- ① EXTERNAL DISK DRIVE
Select [YES] if an external drive is used; select [NO] if an external drive is used.
- ② DEFAULT DISK DRIVE
Specify a default drive number for disk drive operation.
Either F0: (built-in drive) or F1: (external drive) is available.
Use the SELECT key or rotary knob to set the above two parameters.

```

** SET-UP **                                     13-DEC-86 14:29
REAL TIME CLOCK                                DISK DRIVE
  [13]-[DEC]-[86]  [14]:[28]                    EXTERNAL DISK DRIVE [YES] ①
  (PUSH RUN KEY TO START)                       DEFAULT DISK DRIVE [F0] ②

RS-232C PORT CONFIGURATION
CONNECTION    [GDB] (HOST)
BAUD RATE     [9600] BPS
WORD LENGTH   [8] BITS
STOP BIT(S)   [1]
PARITY        [NONE]
TX DELIMITER  [CR+LF]
RX DELIMITER  [CR+LF]
HAND-SHAKE    [NONE]

                                           KNOB EDIT↔
```

Figure 8-4 SETUP Menu Screen

8.5 FLOPPY DISK FORMATTING AND INITIALIZATION

8.5 FLOPPY DISK FORMATTING AND INITIALIZATION

On the UTILITY menu screen, select the SETUP.EXE command. Press the RUN key to load the program. The screen shown in Figure 8-5 is displayed to enable floppy disk formatting and/or initialization. After formatting the disk, the floppy disk must be initialized. It can be assigned a disk name consisting up to 20 characters. The physical formatting operation mentioned above is performed in accordance with the format specified by the user.

- ① **FORMAT:**
Select a physical format. Specify [YES] if both formatting and initialization are to be performed; specify [NO] if only initialization is to be made.
- ② **DRIVE:**
Select the drive to be used for formatting. Either [F0:] (built-in drive) or [F1:] (external drive) is available.
- ③ **DESCRIPTION:**
Input a disk name up to 20 characters. Press the RUN key after setting these parameters. Formatting and initialization will then be performed. When this is completed, the screen shown in Figure 8-6 will display the RESULT window and the disk status information will be output.
Press the STOP key to return to the UTILITY menu. Pressing keys of the MENU key group instead will display their specific menu screens.

** FORMAT **

03-DEC-86 19:17

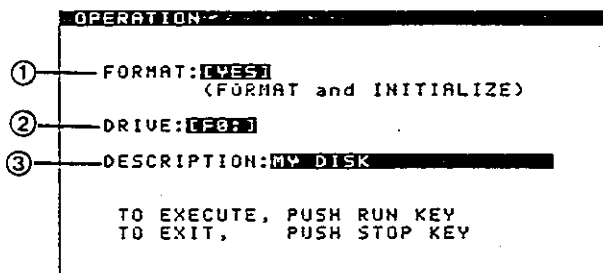

KN08 EDIT↔

Figure 8-5 FORMAT Menu Screen

TR4726
LOGIC ANALYZER
OPERATION MANUAL

8.5 FLOPPY DISK FORMATTING AND INITIALIZATION

** FORMAT **

03-DEC-86 19:19

OPERATION	RESULT
FORMAT: [YES] (FORMAT and INITIALIZE)	DESCRIPTION: MY DISK
DRIVE: [F0:0]	AVAILAVEL BLOCKS: 2530 blocks
DESCRIPTION: MY DISK	USED BLOCKS : 2 blocks
TO EXECUTE, PUSH RUN KEY TO EXIT, PUSH STOP KEY	BAD BLOCKS : 0 block

KNOB EDIT↔

Figure 8-6 End Screen

8.6 DISK COPY

On the UTILITY menu screen, select the DSKCPY.EXE command. Press the RUN key to load the program. The screen shown in Figure 8-7 is displayed to enable the copying of disks.

Copying can be carried out using either two drives (built-in and external) or only one drive (built-in or external). Note that for single-drive copying, it is necessary to alternately change the source and destination floppy disks.

- ① COPY
For the selection item on the left side, specify the designation number of the drive to be used as the destination. For the selection item on the right side, specify the designation number of the drive to be used as the source. In single-drive copying, the drive designation numbers entered on both sides must be the same.
- ② VERIFY
Specify whether the results of copying are to be verified ([YES]) or not ([NO]). If [YES] is specified, verification will take place each time a file is copied. Press the RUN key after making the above two specifications. A message window will then be displayed to guide operator action.

At this time, the floppy disk used as the destination must be already formatted. If it has not yet been formatted, set an appropriate format in accordance with section 8.4.

** DISK COPY **

13-DEC-86 14:12

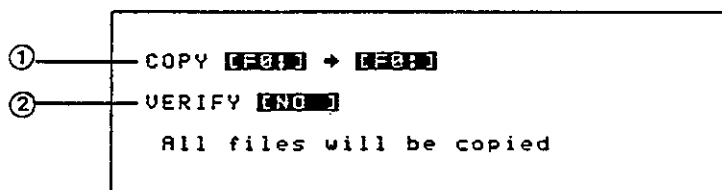

KNOB EDIT↔

Figure 8-7 DSKCPY.EXE Menu Screen

** DISK COPY **

13-DEC-86 14:25

```
COPY [F0:] → [F0:]  
VERIFY [NO ]  
All files will be copied
```

```
Please set source disk to F0:  
OK? (enter RUN) █
```

KNOB EDIT↔

Figure 8-8 Operation-Assisting Screen

The following operation-guide messages will be displayed:

- . "Please set source disk to F0:"
or "Please set source disk to F1:"
- . "Please set destination disk to F0:"
or "Please set destination disk to F1:"

Various messages related to the operational status and results of program execution will be displayed on the bottom line of the screen.

- ① "in progress" --- Command execution in progress
- ② "reading" ----- Reading data from the source disk under way (only for single-drive copying)
- ③ "writing" ----- Writing data from the source disk under way (only for single-drive copying)
- ④ "COMPLETION" ---- Completed
- ⑤ "Use RUN or STOP key" -- RUN or STOP key is available
- ⑥ "ERROR IN VERIFY" ----- Error found during verification

NOTE

Execution of disk copying causes destruction of the acquired data.

MEMO



A large, empty rectangular area with rounded corners, enclosed by a thin black border, intended for writing the memo's content.

TR4726
LOGIC ANALYZER
OPERATION MANUAL

9. PRINT FUNCTIONS AND OPERATIONS

TABLE OF CONTENTS

9. PRINT FUNCTIONS AND OPERATIONS	9 - 1
9.1 PRINT FUNCTION	9 - 1
9.2 OPERATIONS	9 - 2

TR4726
LOGIC ANALYZER
OPERATION MANUAL

9. PRINT FUNCTIONS AND OPERATIONS

9. PRINT FUNCTIONS AND OPERATIONS

9.1 PRINT FUNCTION

The PRINT function can output the display data of the LIST screen of DISPLAY menu to the printer having the RS-232C port. Also, it can output the SYMDEF display data of STATE menu to the printer.

Recommended models:

- Epson's FP-80 series printer
- Epson's model 8148 intelligent serial interface

TR4726
 LOGIC ANALYZER
 OPERATION MANUAL

9. PRINT FUNCTIONS AND OPERATIONS

9.2 OPERATIONS

- (1) Press the COMM key on the DISPLAY screen, and the screen shown in Figure 9-1 will appear.
- (2) Specify the output data range (in the format of "from XX to XX").
- (3) Press the COMM key again, and the on-screen data will be output to the printer (see Figure 9-2).
- (4) To cancel data output, press the STOP key.

```

** DISPLAY ** -TIMING- from ACQ_MEM 00-SEP-88 10:09
FORMAT:[LIST] C-R=0clock GLITCH:[OFF] CLOCK: EXT [ EXT ]
CURSOR:C-00050 GROUP [PRB_F] [PRB_E] [ ] [ ] [ ] [ ]
R-00050 RADIX [BIN] [BIN] [BIN] [BIN] [BIN] [BIN]
DATA: 00000 [ ]
-00006 00001 COMMUNICATION
-00005 00001 [PRINTER]
-00004 00001
-00003 00001
-00002 00001
-00001 00001
T 00000 00001
00001 00001 HEADER [YES]
00002 00001
00003 00001 DATA from 00000 to 00100
00004 00001
00005 00001
00006 00001
00007 00010
00008 00010
00009 00010
00010 00011
RANGE:00 14K
KNOB EDIT↕

```

Figure 9-1 DISPLAY Menu Screen

TR4726
 LOGIC ANALYZER
 OPERATION MANUAL

9. PRINT FUNCTIONS AND OPERATIONS

```

** DISPLAY **  -TIMING-   from ACQ_MEM                                08-SEP-88 12:48
                                                    CLOCK: EXT
  GROUP [PRB_F ] [PRB_E ] [      ] [      ] [      ] [      ] [      ]
  RADIX [ BIN  ] [ BIN  ] [ BIN  ] [ BIN  ] [ BIN  ] [ BIN  ] [ BIN  ]
-----
00000  00000100 00110111
00001  00000110 01001011
00002  00000110 11111111
00003  00000110 11010100
00004  00000110 11010100
00005  00000110 11010100
00006  00000110 11010100
00007  00001000 01001100
00008  00001000 11111111
00009  00001000 01110010
00010  00001100 01001110
00011  00001100 11111111
00012  00001100 01110101
00013  00001100 01110101
00014  00001110 10011111
00015  00001110 10011111
00016  00001110 10011111
00017  00001110 01001111
00018  00001110 11111111
00019  00001110 01100101
00020  00001110 01100101
00021  00000000 01010000
00022  00000000 01111111
00023  00000000 01110101
00024  00000000 01110101
00025  00001110 10011111
  
```

Figure 9-2 Print Example of TIMING LIST Screen

MEMO



A large, empty rectangular box with rounded corners, intended for writing the memo's content. The box is defined by a solid black border.

TR4726
LOGIC ANALYZER
OPERATION MANUAL

10. OPERATION CHECK AND ADJUSTMENT

TABLE OF CONTENTS

10. OPERATION CHECK AND ADJUSTMENT	10 - 3
10.1 SELF-DIAGNOSTIC FUNCTION	10 - 3
10.2 CRT ADJUSTMENT	10 - 4

TR4726
LOGIC ANALYZER
OPERATION MANUAL

10.1 SELF-DIAGNOSTIC FUNCTION

10. OPERATION CHECK AND ADJUSTMENT

10.1 SELF-DIAGNOSTIC FUNCTION

When the POWER switch on the TR4726 is set to the ON position, the self-diagnostic program will automatically activate to check the internal section of the TR4726 for normal functioning. If no errors are detected, "Self-test ended" will be displayed and system software loading will begin.

If "Error XX" is displayed, the ADVANTEST CE headquarters or the authorized ADVANTEST distributor in your area should be contacted. Their addresses and telephone numbers will be listed at the end of this manual.

10.2 CRT ADJUSTMENT

The CRT is preadjusted to the optimum contrast, half-tone contrast, and brightness levels before shipment. If readjustment becomes necessary, change the presettings using the two adjustment controls shown in Figure 10-1.

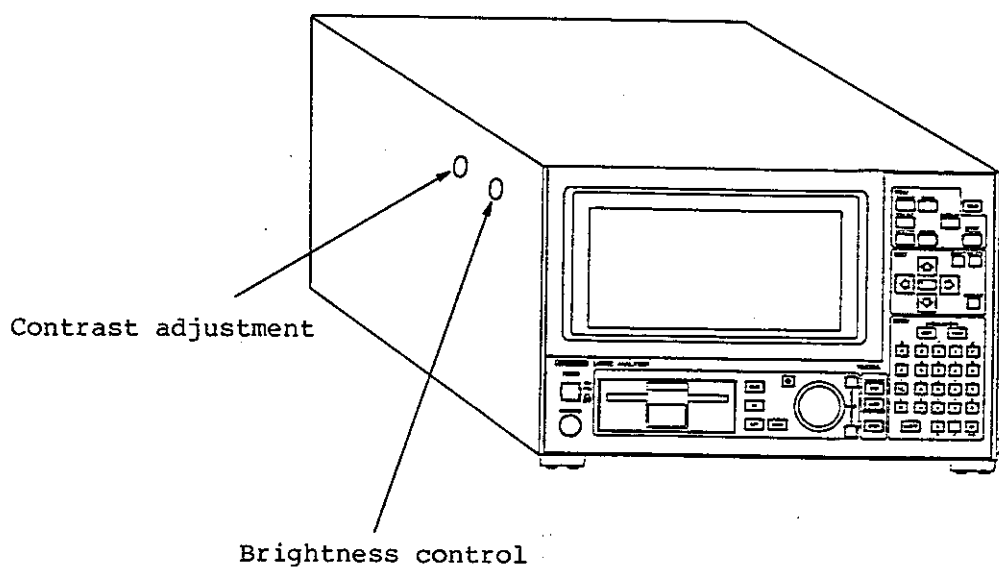

Figure 10-1 CRT Adjustment

TR4726
LOGIC ANALYZER
OPERATION MANUAL

11. STORAGE, CLEANING, AND TRANSPORTATION

TABLE OF CONTENTS

11. STORAGE, CLEANING, AND TRANSPORTATION	11 - 3
11.1 STORING PRECAUTIONS ON TR4726	11 - 3
11.2 CLEANING THE CRT DISPLAY UNIT	11 - 4
11.3 TRANSPORTATION OF THE TR4726	11 - 5

TR4726
LOGIC ANALYZER
OPERATION MANUAL

11.1 STORING PRECAUTIONS ON TR4726

11. STORAGE, CLEANING, AND TRANSPORTATION

11.1 STORING PRECAUTIONS ON TR4726

The TR4726 should be stored in the ambient temperature range of -10°C to $+60^{\circ}\text{C}$. If the TR4726 is not to be used for a long time, it should be covered with a vinyl sheet or put in a corrugated card board box and then stored in a dry place free from direct sunlight.

In addition, floppy disks should be stored at ambient temperatures of $+10^{\circ}\text{C}$ to $+60^{\circ}\text{C}$ at all times.

11.2 CLEANING THE CRT DISPLAY UNIT

Remove the protective filter from the front panel of the CRT display unit periodically and clean the inside of the filter and the CRT display itself using a soft cloth soaked in alcohol. Use only alcohol as the cleaning liquid. Do the following procedure to remove the CRT filter:

- ① Remove the belt cover using a screwdriver.
- ② Remove the two screws from the CRT upper panel.
- ③ Remove the two screws from the bezel.

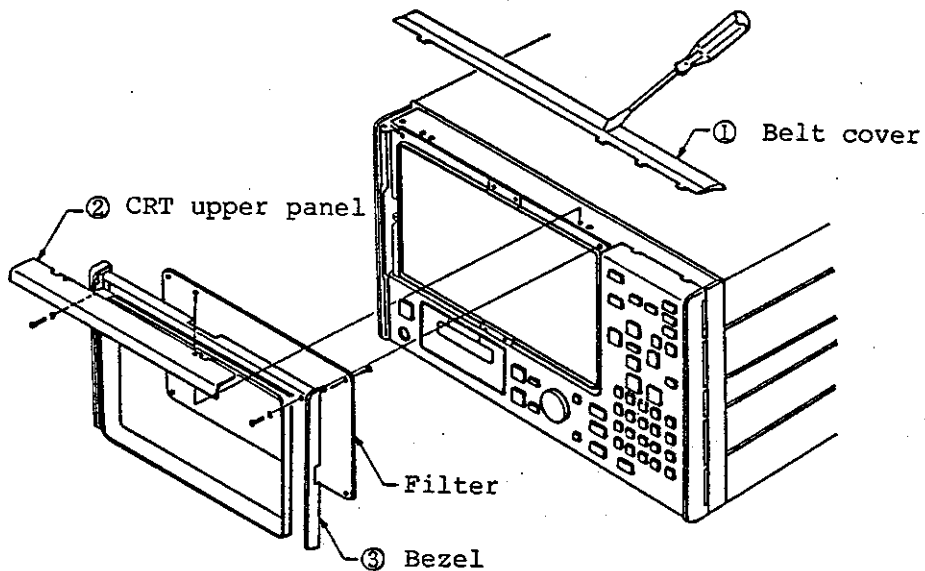

Figure 11-1 Removing the CRT Filter

TR4726
LOGIC ANALYZER
OPERATION MANUAL

11.3 TRANSPORTATION OF THE TR4726

11.3 TRANSPORTATION OF THE TR4726

Use the packing materials (supplied) then transporting the TR4726. If the supplied packing materials cannot be used for some reasons, package the TR4726 as described below.

- ① Wrap the TR4726 in a vinyl cover.
- ② Enclose the TR4726 in a corrugated card board box with a wall thickness of 5 mm or more cover the TR4726 with more than 50 mm thickness of packing.
- ③ After covering the TR4726 in packing, place the attachments in the corrugated card board box. Refill the box with packing. Then close the box, and wrap with packaging strings.

MEMO



A large, empty rectangular box with rounded corners, defined by a dashed border, intended for writing the memo's content.

TR4726
LOGIC ANALYZER
OPERATION MANUAL

12. PERFORMANCE SPECIFICATIONS

TABLE OF CONTENTS

12. PERFORMANCE SPECIFICATIONS	11 - 3
11.1 TR4726	11 - 3
11.2 PERFORMANCE SPECIFICATIONS OF OPT4726+75 (300 MHz TIMING MODULE)	11 - 7
11.3 PERFORMANCE SPECIFICATIONS OF OPT4726+70 (100 MHz TIMING MODULE)	11 - 9
11.4 PERFORMANCE SPECIFICATIONS OF THE STATE ANALYZER	11 - 11
11.5 I/O INTERFACE SPECIFICATIONS	11 - 12
11.5.1 RS-232C Interface Specifications	11 - 12
11.5.2 Video Signal Interface	11 - 12
11.5.3 State Analyzer Trigger Pulse Output	11 - 14
11.5.4 Timing Analyzer Trigger Pulse Output	11 - 14

TR4726
LOGIC ANALYZER
OPERATION MANUAL

12.1 TR4726

12. PERFORMANCE SPECIFICATIONS

12.1 TR4726

Measuring functions

Trace state : Acts as a 48ch state analyzer.

Trace S&T (S → T) and trace S&T (S → T): Option; Acts as a 48ch state analyzer and as a 16ch timing analyzer.

Trace timing: Option; Acts as a 16ch timing analyzer.

Main menu screen

CONFIG : Specifies the data in accordance with input specifications

SYMDEF : Specifies the data in accordance with symbol/code specifications

TRACE : Specifies the data in accordance with trace control specifications

DISPLAY: Specifies the data in accordance with display specifications

PROGRAM: Specifies the data in accordance with program specifications

Submenu screen

FD/GET/SAVE : Specifies the data in accordance with disk file specifications; Multi-window display

COMM : Specifies the data in accordance with communications specifications; Multi-window display

State analyzer : (Acts together with simultaneous analysis module OPT4726+06) See section 12.4.

Symbol/code specifications

Symbol : Symbol name assigned for each numeric string

Symbol name : 8 alphanumerics or less

Symbol definition capacity: Up to 100 symbols for each input group; Up to 200 symbols for all input groups

No. of symbols used : Trace control --- Up to 50 symbols for each input group; Display --- All defined symbols can be used.

Code : Code name assigned for each numeric string

Code name : 8 alphanumerics or less

Code definition capacity : Up to 256 codes for each input group having 8 channels or less: Up to 512 codes for all input groups

No. of codes used : Trace control --- Up to 50 codes for each input group; Display --- All defined codes can be used.

TR4726
LOGIC ANALYZER
OPERATION MANUAL

12.1 TR4726

Trace control specifications

Trace control is performed according to: (1) a maximum of 4 sets of trace/window conditions, each set consisting of Store, Enable, Trigger, Disable, Trigger Pass, and Delay, and; (2) a maximum of 4 combinations of trace/window conjunctions.

Store : 0, 1, 2, -----, 1024 states (Exponential multipliers of 2)
Enable : Binary, octal, hexadecimal, Don't Care pattern/symbol/code, ASCII code
Trigger : Binary, octal, hexadecimal, Don't Care pattern/symbol/code, ASCII code, NOT, OR
Disable : Binary, octal, hexadecimal, Don't Care pattern/symbol/code, ASCII code
Trigger pass : 1 to 256 states
Delay : From -(Store-1) through 0 to +3072 states

Trace/window conjunctions

THEN : Move to the next trace/window condition
AGAIN : Repetition of the particular trace/window condition
TOP : Move to the first trace/window condition
STOP : Stop of measurement execution
Trigger arming : For trace S&T (S → T), the trigger of the state analyzer dearms the timing analyzer. For trace S&T (T → S), the trigger of the timing analyzer dearms the state analyzer.

Display specifications

Display data source

Acquisition memory, reference memory, and file

Display item : 8 items; The order of display can be changed for each input group; Overlapping display of identical input group is possible; A specific input group can be erased.
Display format : State display in binary, octal, hexadecimal, pattern/symbol/code, ASCII code, etc.
Memory-to-memory transfer: operation : Transfer of display data to reference memory, display of reference memory data, and display of acquisition memory data
Data scroll : Vertical scroll using the scroll knob, and vertical page-by-page scroll using the page scroll key
Special display : Trigger display for trigger, display of memory segments between trace and window
Others : As per the display specifications of the personality kit

Timing analyzer

See sections 12.2 and 12.3, "Performance Specifications of the OPT4726+75/OPT4726+70."

TR4726
LOGIC ANALYZER
OPERATION MANUAL

12.1 TR4726

Data processor

Disk file operation specifications

Disk capacity : 632.5KB (formatted), 1MB (unformatted)
Disk type : Two types (system disk and user disk) for each personality kit
No. of files : Up to 199 (within one user disk)
File types : Three
System-saved file : Up to 99 for each menu screen
Registered file : Up to 1 for each menu screen
User file : Up to 199
Operation types : 12
DIRECTORY-of-MENU operation : Only the menu-screen related files are displayed in terms of file name, file size, file attribute, and date and time created.
DIRECTORY-of-ALL operation: All files are displayed in terms of file name, file size, file attribute, and date and time created.
REGISTER operation : Registered files are created.
PURGE operation : System-saved files are deleted in lump.
DELETE operation : User files are deleted.
FORMAT operation : User files are created. It is possible to write disk explanatory statements (20 alphanumeric or less) into disk during file creation.
RENAME operation : User files are renamed.
COPY operation : File-to-file copying
STATUS-of-FILES operation : Registered/system-saved/user file quantities and sizes are displayed.
STATUS-of-DISK operation : Disk ID, disk explanatory statements, and disk operational status are displayed.
GET operation : Data within file are displayed on menu screen.
SAVE operation : Menu screen data are saved into file.

Printer specifications

Connectible unit : Printer with RS-232C interface
Output data : SYMDEF, DISPLAY, and PROGRAM menu screen data (But only printable data)

Disk copy specifications

Copy function : All files within the source disk (inserted in F0:) are copied onto the destination disk (inserted in F1:) [Auxiliary disk required]
Source disk : System disk or user disk
Destination disk : Blank disk, system disk, or user disk

TR4726
 LOGIC ANALYZER
 OPERATION MANUAL

12.1 TR4726

Clock specifications

- Data setting : Year, month, day, hour, minute
- Use of clock : It is continuously displayed on CRT and written onto file during file creation
- Backup time : More than 2 weeks after full charging of battery

Help specifications

- Help (menu item) function : Displays menu data that can be set
- Help (key) function : Displays brief description of keys, news on version upgrade, etc.

I/O signal specifications

- State analyzer trigger pulse output : BNC connector, TTL level, negative pulse, approx. 50 ns wide, output in synchronization with the internal clock existing after the occurrence of trigger.
- Timing analyzer trigger pulse output : BNC connector, TTL level, negative pulse, approx. 50 ns wide, output in synchronization with the internal clock existing after the occurrence of trigger.
- Video signal output : BNC connector
- External floppy disk drive interface : With 37-pin D-Sub connector; for accessory drive unit
- Serial communications interface : With 25-pin D-Sub connector; conforms to EIA RS-232C standard
- External keyboard interface : With 12-pin round connector; for accessory keyboard
- Probe test output : With 50-pin amphenol connector; Probe test pattern output.

General specifications

- CRT : 5-inch x 9-inch, electromagnetic deflection type, B31 fluorescent material, 80 characters x 24 lines / screen Floppy disk drive: 3.5-inch, double-sided double-density, 1MB (unformatted)
- Operating temperature : +5°C to +40°C
- Operating humidity : 20% to 80% RH (non-condensing)
- Power supply : 90 to 132 VAC, 180 to 249 VAC, 50/60 Hz
 Outline dimensions: Approx. 350 (W) x 220 (H) x 500 (D) mm
- Weight : Less than 25 kg
- Optional power supply : See below.

Option No.	Standard	Option 40
Supply voltage	90 to 132 VAC	180 to 249 VAC

TR4726
LOGIC ANALYZER
OPERATION MANUAL

12.2 PERFORMANCE SPECIFICATIONS OF OPT4726+75 (300 MHz TIMING MODULE)

12.2 PERFORMANCE SPECIFICATIONS OF OPT4726+75 (300 MHz TIMING MODULE)

This option operates as a 300 MHz timing analyzer when it is combined with the TR4726.

- No. of input channels : 16 data channels/2 clock channels
2 qualifier channels
- Maximum sampling rate : Internal clock --- 3.3 ns (at 300 MHz);
External clock --- 10 ns (at 100 MHz)
- Acquisition mode : 1. 16ch data ----- Glitch detectible,
100 MHz (maximum);
2. 16ch data ----- Glitch not detectible,
150 MHz (maximum);
3. 8ch data ----- Glitch detectible,
150 MHz (maximum);
4. 8ch data ----- Glitch not detectible,
300 MHz (maximum)

Acquisition memory capacity:

No. of Data Channels	Sampling Clock Frequency	Maximum Memory Depth (bits/ch)	
		Glitch ON	Glitch OFF
16	100 MHz or less	16K	32K
	150 MHz	-	32K
8	150 MHz or less	32K	64K
	200 MHz	-	64K

- Data setup/hold time : 3 ns/0 ns
- Glitch detection pulse width : 3 ns, minimum (at sampling rates less than 150 MHz)
- Clock qualifier : 2 ns, setup/hold --- 3 ns/0 ns
- Sampling clock : (Internal) 50 ns to 10 ns (in 1-2-5 steps) and 6.7 ns, 3.3 ns;
(External) 2ch, DC to 100 MHz, clock generation formula (CKn for clock, CQn for qualifier) to be as follows:
SCK=CK1 † . (CQ1.CQ2)
+CK2 ‡ . (CQ1 CQ2)
where † should be read to mean either † or ‡ and SCK must not exceed 150 MHz.

TR4726
 LOGIC ANALYZER
 OPERATION MANUAL

12.2 PERFORMANCE SPECIFICATIONS OF OPT4726+75 (300 MHz TIMING MODULE)

Trigger function : 4-level sequential trigger with reset function (ENABLE 3-stage + trigger / DISABLE)
 ENABLE ---- Matchpattern, 3-stage sequential
 DISABLE --- Matchpattern, ENABLE sequence reset
 TRIGGER --- Match pattern True/False/Glitch/Edge/Serial
 Possible to set Glitch/Edge for each channel.
 ORed between channels and ANDED with match pattern.
 For Serial, the occurrence of trigger is identified by matching of up to 16 bits of serial data array. Setting possible only for 0 channel. Can be used only for external clocks.
 FILTER ---- 1 to 15 clocks (only for internal clocks) Possible to set ENABLE, TRIGGER, and DISABLE independently.
 EVENT ----- For ENABLE/DISABLE, 1 to 15 events (only for external clocks); For TRIGGER, 1 to 65536 events.
 DELAY ----- -(memory depth + 1) to (65536 - memory depth)

Input probe : No. of channles ---- 8 data channels/1 clock channel/1 qualifier channel (per probe)
 Impedance ----- Approx. 1M Ω /5pF or less
 Frequency band ----- DC to 150 MHz
 Sensitivity ----- 200 mVp-p or less
 Threshold voltage -- TTL(+1.4 V)/ECL(-1.3 V)/VAR(+6.35 V to -6.35 V)
 Resolution 50 mV
 Accuracy $\pm 4\% \pm 140$ mV
 Dynamic range ----- VTH ± 5 V
 Maximum input voltage --- ± 30 V

Skew : 3ns or less (probe included)

TR4726
LOGIC ANALYZER
OPERATION MANUAL

12.3 PERFORMANCE SPECIFICATIONS OF OPT4726+70 (100 MHz TIMING MODULE)

12.3 PERFORMANCE SPECIFICATIONS OF OPT4726+70 (100 MHz TIMING MODULE)

This option operates as a 100 MHz timing analyzer when it is combined with the TR4726.

- No. of input channels : 16 data channels (for internal sampling); 14 data channels + 2 clock channels (for external sampling)
- Maximum sampling rate : Internal clock --- 10 ns (at 100 MHz);
External clock --- 15 ns (at 70 MHz)
- Acquisition mode : 1. 16ch data ----- Glitch detectible, 100 MHz (maximum);
2. 16ch data ----- Glitch not detectible, 100 MHz (maximum);
3. 8ch data ----- Glitch detectible, 100 MHz (maximum);
4. 8ch data ----- Glitch not detectible, 100 MHz (maximum);

Acquisition memory capacity:

No. of Data channels	Sampling Clock Frequency	Maximum Memory Depth (bits/ch)	
		Glitch ON	Glitch OFF
16	100 MHz or less	16K	32K
8	100 MHz or less	32K	64K

- Data setup/hold time : 5 ns/0 ns
- Glitch detection pulse width : 5 ns, minimum
- Sampling clock : (Internal) 50ms to 10ns (in 1-2-5 steps);
(External) 2ch, DC to 70 MHz, clock generation formula (CKn for clock) to be as follows:
 $SCK = CK1 \downarrow + CK2 \uparrow$
where \downarrow should be read to mean either \uparrow or \downarrow and SCK must not exceed 70 MHz.
- Trigger function : 4-level sequential trigger with reset function (ENABLE 3-state + trigger / DISABLE)
ENABLE --- Match pattern, 3-stage sequential
DISABLE -- Match pattern, ENABLE sequence reset

TR4726
LOGIC ANALYZER
OPERATION MANUAL

12.3 PERFORMANCE SPECIFICATIONS OF OPT4726+70 (100 MHz TIMING MODULE)

TRIGGER -- Match pattern True/False/Glitch/
Edge/Serial
Possible to set Glitch/Edge for
each channel.
ORed between channel.a and
ANDed+with matchpattern. For
Serial, the occurrence of trigger
is identified by matching of up to
16 bits of serial data array.
Setting possible only for 0
channel. Can be used only for
external clocks.

FILTER --- 1 to 15 clocks (only for internal
clocks)
Possible to set each of ENABLE,
TRIGGER, and DISABLE independently.

EVENT ---- For ENABLE/DISABLE, 1 to 15 events
(only for external clocks); For
TRIGGER, 1 to 65536 events.

DELAY ---- -(memory depth + 1) to (65536 -
memory depth)

Input probe

: No. of channels ---- 8 data channels (In
external sampling mode, clocks via one
channel become an input. At this time, seven
channels are used as data channels.)
Impedance ----- Approx. $1M\Omega/8$ pF or less
Frequency band ----- DC to 100 MHz
Sensitivity ----- 200 mVp-p or less
Threshold voltage -- TTL(+1.4 V)/ECL(-1/3 V)
VAR(+12.7 V to -12.7 V)
Resolution 100 mV
Accuracy $\pm 4\% \pm 140$ mV
Dynamic range ----- VTH ± 10 V
Maximum input voltage --- ± 50 V

Skew

: 5ns or less

TR4726
LOGIC ANALYZER
OPERATION MANUAL

12.4 PERFORMANCE SPECIFICATIONS OF THE STATE ANALYZER

12.4 PERFORMANCE SPECIFICATIONS OF THE STATE ANALYZER

Input specifications

Input group : Input groups are defined by a set of input channels.
No. of input groups : 6 (maximum)
Input group name : 6 alphanumeric or less
Others : Conform to the input specifications of the personality kit used.

Memory specifications

Acquisition memory width : 48ch
Acquisition memory depth : 1024-state
Acquisition memory write speed : 20 MHz, max.
Reference memory width : 48ch
Reference memory depth : 1024-state

TR4726
LOGIC ANALYZER
OPERATION MANUAL

12.5 I/O INTERFACE SPECIFICATIONS

12.5 I/O INTERFACE SPECIFICATIONS

This section describes the specifications of the signals input and output from the TR4726.

12.5.1 RS-232C Interface Specifications

The RS-232C connector on the rear panel of the TR4726 uses a 25-pin D-sub connector (BD-25S, female type).

The specifications conform to the RS-232C standard.

As listed below, two types of pin connections are provided to suit the particular cabling requirements.

- (1) The following table applies to the case where TxD is set for the PIN No. 2 menu item on the COMM menu screen:

Pin No.	Symbol	Meaning
1	FG	Frame Ground
2	TxD	Transmitted Data
3	RxD	Received Data
6	DSR	Data Set Ready
7	SG	Signal Ground
20	DTR	Data Terminal Ready

TR4726
LOGIC ANALYZER
OPERATION MANUAL

12.5 I/O INTERFACE SPECIFICATIONS

- (2) The following table applies to the case where RxD is set for the PIN No. 2 menu item on the COMM menu screen:

Pin No.	Symbol	Meaning
1	FG	Frame Ground
2	RxD	Received Data
3	TxD	Transmitted Data
6	DTR	Data Terminal Ready
7	SG	Signal Ground
20	DSR	Data Set Ready

TxD and DTR are transmitted by SN75188N (operating on +12 V power), and RxD and DSR are received by SN75189AN.

12.5.2 Video Signal Interface

The same type of composite video signal data as that displayed on the CRT screen is output from the "VIDEO OUT" BNC connector located on the rear panel of the TR4726.

By using this signal data, it becomes possible to display the data on an external large-size CRT unit or to hard-copy onto a video printer.

Horizontal synchronizing signal frequency: 15750 Hz
Vertical synchronizing signal frequency : 60 Hz
(Non-interlaced scanning)

The output level is adjusted at the factory so it is approximately 1 Vp-p when the output signal line is terminated with a 75-ohm resistor.

TR4726
LOGIC ANALYZER
OPERATION MANUAL

12.5 I/O INTERFACE SPECIFICATIONS

12.5.3 State Analyzer Trigger Pulse Output

The trigger pulses of the state analyzer can be output via the "TRIG OUT (SYNC)" BNC connector located on the rear panel of the TR4726. To output these trigger pulses, set the TRIG OUT (SYNC) menu item for trace/window parameters to ON in advance on the TRACE menu screen. (See subsection 4.3.3 for further details.) Trigger pulses will be output when triggers occur during measurement. These trigger pulses can be utilized to synchronize external logic analyzers or oscilloscopes with the state analyzer.

These pulses possess a pulse width of 50 ns at the TTL level, with a negative polarity.

12.5.4 Timing Analyzer Trigger Pulse Output

The trigger pulses of the timing analyzer can be output via the "TRIG OUT (ASYNC)" BNC connector located on the rear panel of the TR4726. These trigger pulses will be output when triggers occur during measurement. These trigger pulses can be utilized to synchronize external logic analyzers or oscilloscopes with the state analyzer. These pulses possess a pulse width of 50 ns at the TTL level, with a negative polarity.

TR4726
LOGIC ANALYZER
OPERATION MANUAL

13. OPERATIONAL DESCRIPTION

TABLE OF CONTENTS

13. OPERATIONAL DESCRIPTION	13 - 3
13.1 OVERVIEW	13 - 3
13.2 OPERATIONAL DESCRIPTION OF EACH BLOCK	13 - 5
13.2.1 Main Facility	13 - 5
13.2.2 Optional Facility	13 - 5

TR4726
LOGIC ANALYZER
OPERATION MANUAL

13.1 OVERVIEW

13. OPERATIONAL DESCRIPTION

13.1 OVERVIEW

This section offers an overview of TR4726 logic analyzer operation. The block diagram of this instrument is given in Figure 13-1. The instrument consists of the main facility and an optional facility.

(1) Main facility

This block contains a CPU, an external interface control unit, a power control unit, etc.

(2) Optional facility

This block can contain a high-speed timing analysis module (OPT4726+75), a 100 MHz timing module (OPT4726+70), and a synchronous analysis module (OPT4726+06).

TR4726
 LOGIC ANALYZER
 OPERATION MANUAL

13.1 OVERVIEW

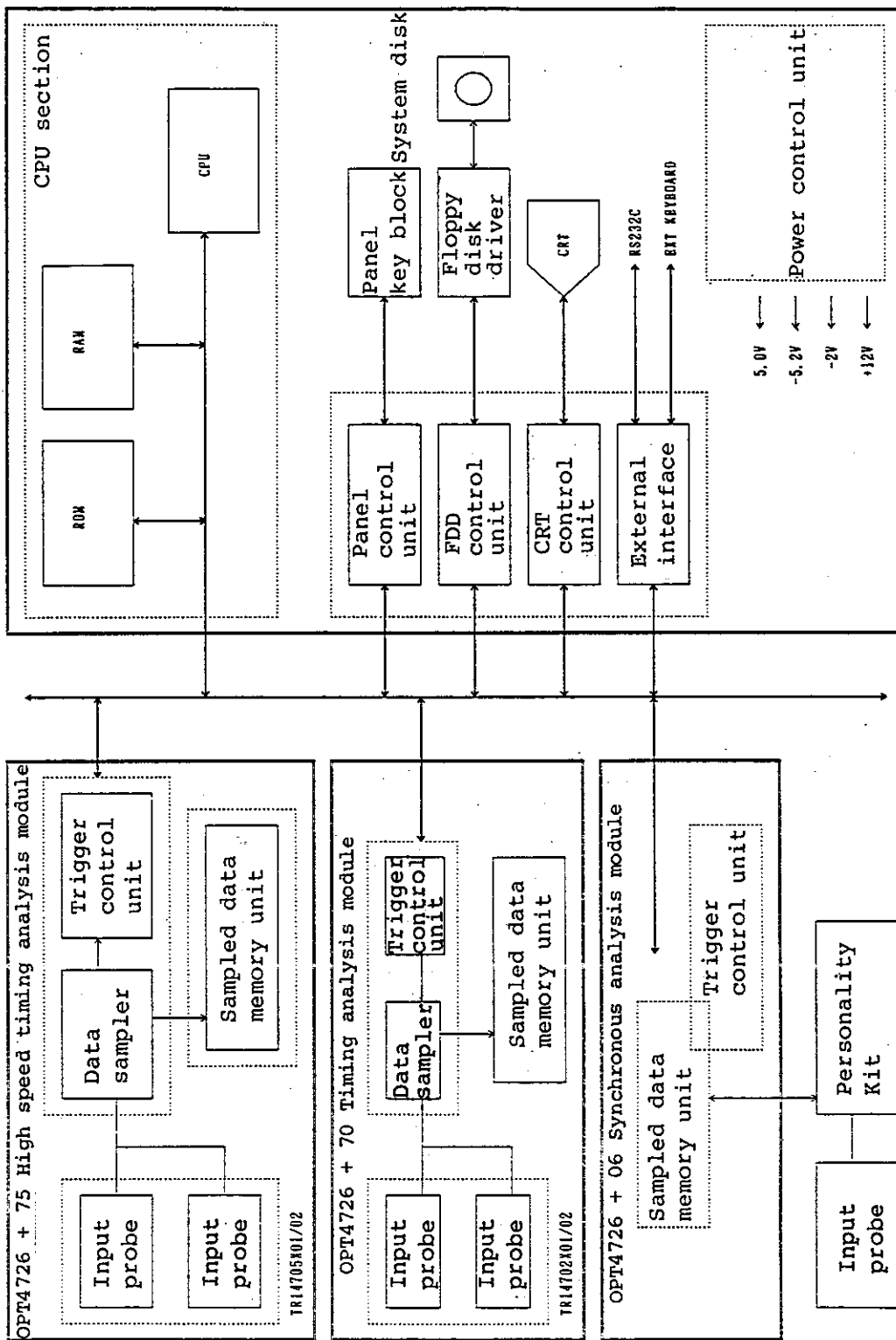

Figure 13-1 TR4726 Schematic Block Diagram

TR4726
LOGIC ANALYZER
OPERATION MANUAL

13.2 OPERATIONAL DESCRIPTION OF EACH BLOCK

13.2 OPERATIONAL DESCRIPTION OF EACH BLOCK

13.2.1 Main Facility

(1) CPU section

This section, which has a sophisticated 16-bit microprocessor (80186) as the main CPU, contains

CPU 80186
ROM 512 Kbytes
RAM 1 Mbytes

and performs system software operation and data analysis.

(2) External interface control section

This section consists of a panel control unit, an FDD control unit, a CRT control unit, and an external interface control unit.

Panel control unit: Receives and delivers front-panel key block information between CPUs.

FDD control unit : Controls 3.5-inch micro floppy disk drives. User disks and system disks interchange data with the CPU main memory via this unit.

CRT control unit : Controls menu display and acquired-data display.

External interface: Enables connection to a printer (with an RS-232C interface function) and to an accessory keyboard.

Each of the above units is controlled by a dedicated LSI.

(3) Power control section

The TR4726 incorporates four types of power supplies: +5.0 V, -5.2 V, -2 V, and +12 V.

All these power supplies are of the moduled switching type, and they are used for the following purposes:

+5.0 V ... TTL line
-5.2 V ... ECL line
-2.0 V ... ECL line
+12 V Analog line

13.2.2 Optional Facility

(1) Synchronous analysis module

The address bus, data bus, and control signal data from the system under test (SUT) are transmitted to the synchronous analysis module via input probes (probes that correspond to each CPU).

TR4726
LOGIC ANALYZER
OPERATION MANUAL

13.2 OPERATIONAL DESCRIPTION OF EACH BLOCK

In personality kits, sampling clocks are produced from the incoming control signal and these clocks are used to sample and latch the incoming data and addresses.

The synchronous analysis module, which consists of a sample-data memory unit and a trigger control unit, records sample data sent from the personality kit and controls the recorded data (trace control).

The recorded data is subsequently reproduced as a state diagram on the CRT display via the CPU.

(2) Timing analysis module

The timing analysis module consists of:

1. Input probe
2. Data sampler/trigger control unit
3. Sample-data memory unit

1. Input probe

The input probe, which consists of an impedance converter and an analog converter, shapes the waveform of input data according to the condition settings that match the SUT (system under test) and then transfers the data to the data sampler.

2. Data sampler/trigger control unit

The data that has been waveform-shaped by the input probe is subsequently sent to the data sampler, in which the data is then sampled using internal/external sampling clocks.

The trigger control unit controls the written of the sampled data into the sampled-data memory. (Trace control)

This section uses custom LSIs to ensure high-speed data processing and 4-level sequential trigger function implementation.

3. Sampled-data memory unit

The sampled-data memory unit, which consists of high-speed memories and a write control unit, stores into memory the data that has been sampled by the data sampler.

The TR4726 incorporates high-speed CMOS memories and interleaved memories, which provides the instrument with high-speed processing capabilities, power savings, and a high memory capacity.

The CPU reads such data from the sampled-data memory and then reproduces the data as timing signals.

TR4726
LOGIC ANALYZER
OPERATION MANUAL

LIST OF FIGURES

LIST OF FIGURES

<u>Figure No.</u>	<u>Title</u>	<u>Page</u>
Figure 1-1	Power Cable Plug and Adaptor	1 - 7
Figure 2-1	Connection of Probes	2 - 4
Figure 2-2	Probes E and F Configurations and Their Component Part Names (OPT4726+70)	2 - 5
Figure 2-3	Probes E and F Configurations and Their Component Part Names (OPT4726+75)	2 - 6
Figure 2-4	Display at the End of Loading (<u>CONFIG</u> Menu Display)	2 - 8
Figure 3-1	Initial Screen of <u>CONFIGURATION</u>	3 - 4
Figure 3-2	<u>TRACE</u> Menu Screen	3 - 5
Figure 3-3	<u>DISPLAY</u> Menu Screen	3 - 6
Figure 4-1	Menu Screen and Setting Functions (1/2)	4 - 4
Figure 4-1	Menu Screen and Setting Functions (2/2)	4 - 5
Figure 4-2	Initial Screen of the <u>CONFIG</u> Menu (Timing Analyzer)	4 - 6
Figure 4-3	External Clock Settin	4 - 8
Figure 4-4	<u>TRACE</u> Menu Screen	4 - 11
Figure 4-5	<u>TRACE</u> Menu (SERIAL) Display	4 - 13
Figure 4-6	Trigger Setting Process	4 - 14
Figure 4-7	Initial <u>DISPLAY</u> Menu	4 - 15
Figure 4-8	<u>DISPLAY</u> [LIST] Menu Screen	4 - 21
Figure 5-1	How to Use the Write-Protect Tab	5 - 5
Figure 5-2	COPY Function and Files	5 - 22
Figure 7-1	COMM Menu Screen	7 - 4
Figure 7-2	Normal Sequence	7 - 6
Figure 7-3	Forced-Interruption Sequence	7 - 7
Figure 7-4	Time-Out Sequence	7 - 8
Figure 8-1	UTILITY Menu Screen	8 - 3
Figure 8-2	SETUP Menu Screen	8 - 4
Figure 8-3	SETUP Menu Screen (for RS-232C Parameter Setting)	8 - 6
Figure 8-4	SETUP Menu Screen	8 - 7
Figure 8-5	FORMAT Menu Screen	8 - 8
Figure 8-6	End Screen	8 - 9
Figure 8-7	DSKCPY.EXE Menu Screen	8 - 10
Figure 8-8	Operation-Assisting Screen	8 - 11
Figure 9-1	DISPLAY Menu Screen	9 - 4
Figure 9-2	Print Example of TIMING LIST Screen	9 - 5
Figure 10-1	CRT Adjustment	10 - 4
Figure 11-1	Removing the CRT Filter	11 - 4
Figure 13-1	TR4726 Schematic Block Diagram	13 - 4

TR4726
LOGIC ANALYZER
OPERATION MANUAL

LIST OF TABLES

LIST OF TABLES

<u>Table No.</u>	<u>Title</u>	<u>Page</u>
Table 5-1	Classification of Files	5 - 8

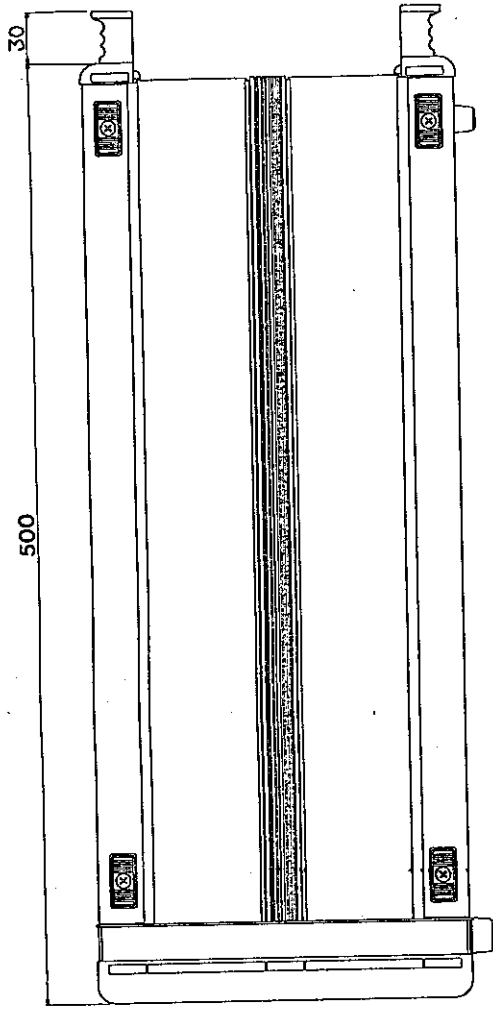

SIDE VIEW

TR4726
EXTERNAL VIEW

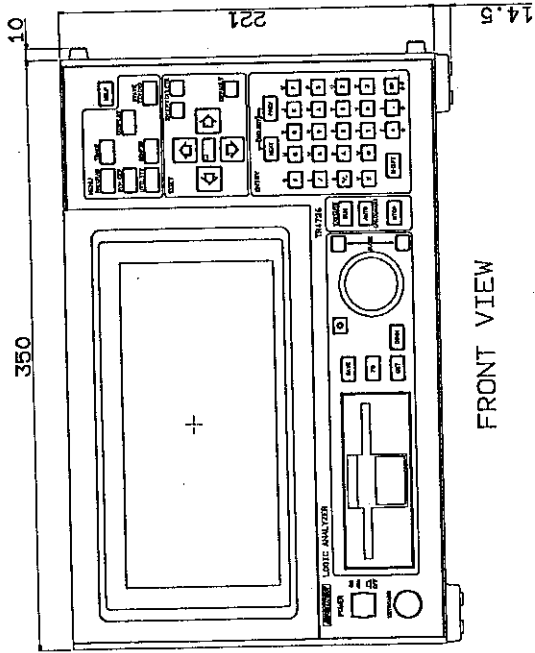

FRONT VIEW

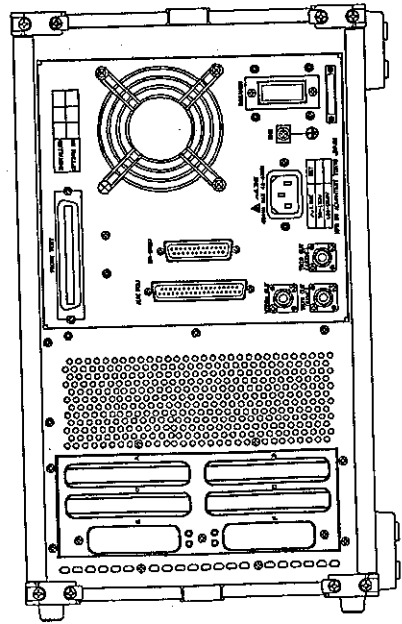

REAR VIEW

4726EXTL-610-A

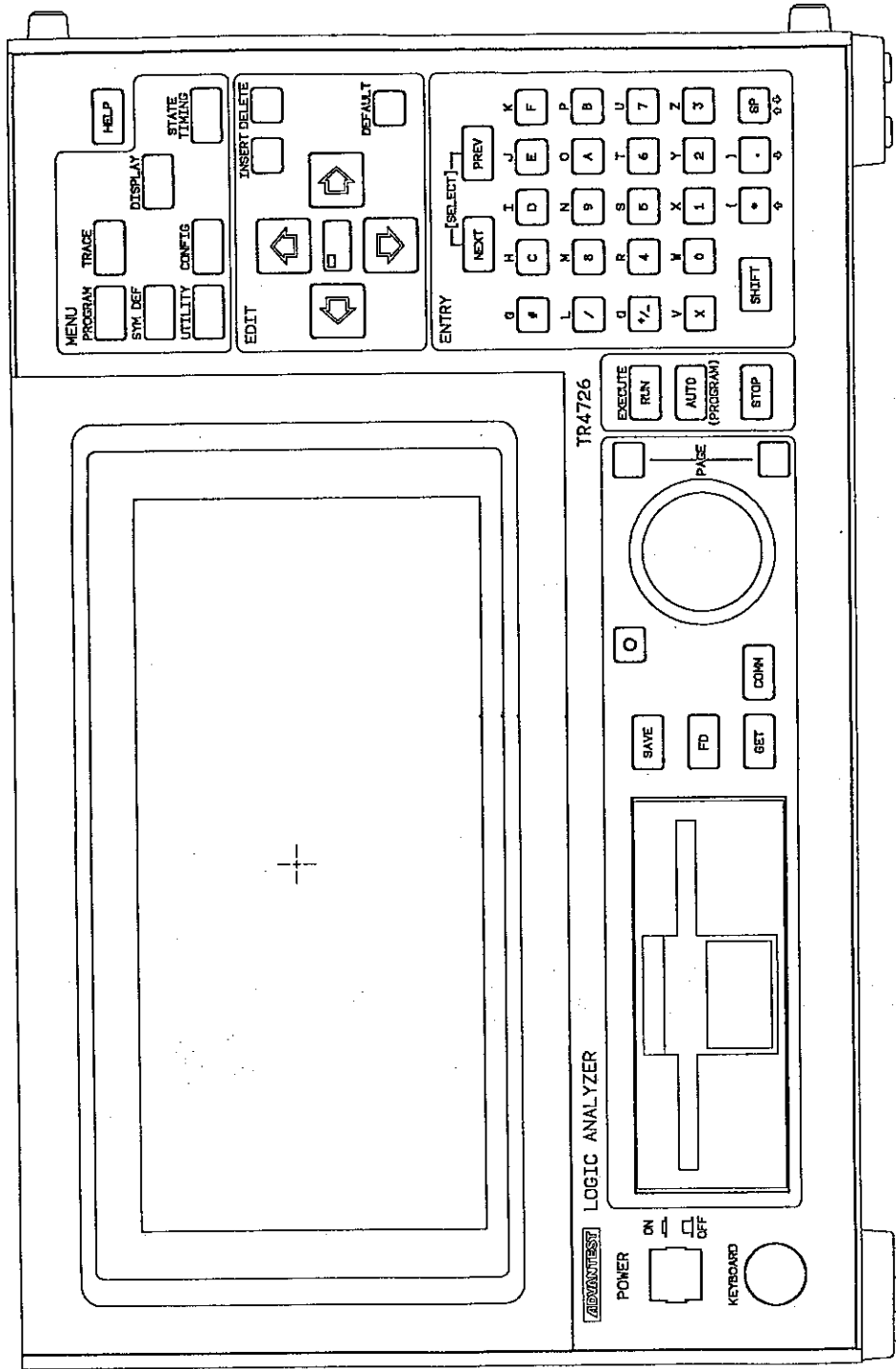

FRONT VIEW

4726EXT2-610-A

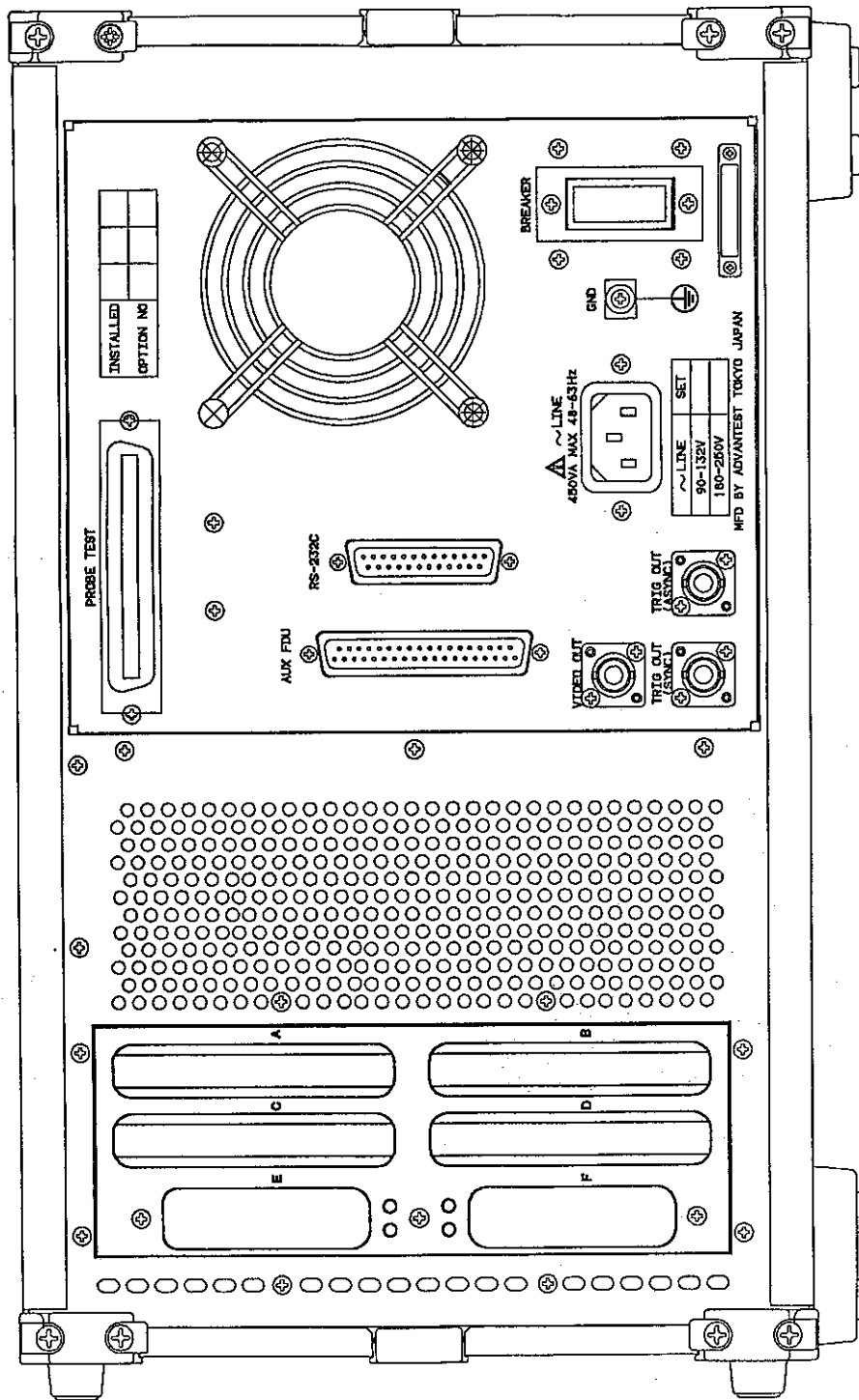

REAR VIEW

4726EXT3-610-A

IMPORTANT INFORMATION FOR ADVANTEST SOFTWARE

PLEASE READ CAREFULLY: This is an important notice for the software defined herein. Computer programs including any additions, modifications and updates thereof, operation manuals, and related materials provided by Advantest (hereafter referred to as "SOFTWARE"), included in or used with hardware produced by Advantest (hereafter referred to as "PRODUCTS").

SOFTWARE License

All rights in and to the SOFTWARE (including, but not limited to, copyright) shall be and remain vested in Advantest. Advantest hereby grants you a license to use the SOFTWARE only on or with Advantest PRODUCTS.

Restrictions

- (1) You may not use the SOFTWARE for any purpose other than for the use of the PRODUCTS.
- (2) You may not copy, modify, or change, all or any part of, the SOFTWARE without permission from Advantest.
- (3) You may not reverse engineer, de-compile, or disassemble, all or any part of, the SOFTWARE.

Liability

Advantest shall have no liability (1) for any PRODUCT failures, which may arise out of any misuse (misuse is deemed to be use of the SOFTWARE for purposes other than its intended use) of the SOFTWARE. (2) For any dispute between you and any third party for any reason whatsoever including, but not limited to, infringement of intellectual property rights.

LIMITED WARRANTY

1. Unless otherwise specifically agreed by Seller and Purchaser in writing, Advantest will warrant to the Purchaser that during the Warranty Period this Product (other than consumables included in the Product) will be free from defects in material and workmanship and shall conform to the specifications set forth in this Operation Manual.
2. The warranty period for the Product (the "Warranty Period") will be a period of one year commencing on the delivery date of the Product.
3. If the Product is found to be defective during the Warranty Period, Advantest will, at its option and in its sole and absolute discretion, either (a) repair the defective Product or part or component thereof or (b) replace the defective Product or part or component thereof, in either case at Advantest's sole cost and expense.
4. This limited warranty will not apply to defects or damage to the Product or any part or component thereof resulting from any of the following:
 - (a) any modifications, maintenance or repairs other than modifications, maintenance or repairs (i) performed by Advantest or (ii) specifically recommended or authorized by Advantest and performed in accordance with Advantest's instructions;
 - (b) any improper or inadequate handling, carriage or storage of the Product by the Purchaser or any third party (other than Advantest or its agents);
 - (c) use of the Product under operating conditions or environments different than those specified in the Operation Manual or recommended by Advantest, including, without limitation, (i) instances where the Product has been subjected to physical stress or electrical voltage exceeding the permissible range and (ii) instances where the corrosion of electrical circuits or other deterioration was accelerated by exposure to corrosive gases or dusty environments;
 - (d) use of the Product in connection with software, interfaces, products or parts other than software, interfaces, products or parts supplied or recommended by Advantest;
 - (e) incorporation in the Product of any parts or components (i) provided by Purchaser or (ii) provided by a third party at the request or direction of Purchaser or due to specifications or designs supplied by Purchaser (including, without limitation, any degradation in performance of such parts or components);
 - (f) Advantest's incorporation or use of any specifications or designs supplied by Purchaser;
 - (g) the occurrence of an event of force majeure, including, without limitation, fire, explosion, geological change, storm, flood, earthquake, tidal wave, lightning or act of war; or
 - (h) any negligent act or omission of the Purchaser or any third party other than Advantest.
5. **EXCEPT TO THE EXTENT EXPRESSLY PROVIDED HEREIN, ADVANTEST HEREBY EXPRESSLY DISCLAIMS, AND THE PURCHASER HEREBY WAIVES, ALL WARRANTIES, WHETHER EXPRESS OR IMPLIED, STATUTORY OR OTHERWISE, INCLUDING, WITHOUT LIMITATION, (A) ANY WARRANTY OF MERCHANTABILITY OR FITNESS FOR A PARTICULAR PURPOSE AND (B) ANY WARRANTY OR REPRESENTATION AS TO THE VALIDITY, SCOPE, EFFECTIVENESS OR USEFULNESS OF ANY TECHNOLOGY OR ANY INVENTION.**
6. **THE REMEDY SET FORTH HEREIN SHALL BE THE SOLE AND EXCLUSIVE REMEDY OF THE PURCHASER FOR BREACH OF WARRANTY WITH RESPECT TO THE PRODUCT.**
7. **ADVANTEST WILL NOT HAVE ANY LIABILITY TO THE PURCHASER FOR ANY INDIRECT, INCIDENTAL, SPECIAL, CONSEQUENTIAL OR PUNITIVE DAMAGES, INCLUDING, WITHOUT LIMITATION, LOSS OF ANTICIPATED PROFITS OR REVENUES, IN ANY AND ALL CIRCUMSTANCES, EVEN IF ADVANTEST HAS BEEN ADVISED OF THE POSSIBILITY OF SUCH DAMAGES AND WHETHER ARISING OUT OF BREACH OF CONTRACT, WARRANTY, TORT (INCLUDING, WITHOUT LIMITATION, NEGLIGENCE), STRICT LIABILITY, INDEMNITY, CONTRIBUTION OR OTHERWISE. TORT (INCLUDING, WITHOUT LIMITATION, NEGLIGENCE), STRICT LIABILITY, INDEMNITY, CONTRIBUTION OR OTHERWISE.**
8. **OTHER THAN THE REMEDY FOR THE BREACH OF WARRANTY SET FORTH HEREIN, ADVANTEST SHALL NOT BE LIABLE FOR, AND HEREBY DISCLAIMS TO THE FULLEST EXTENT PERMITTED BY LAW ANY LIABILITY FOR, DAMAGES FOR PRODUCT FAILURE OR DEFECT, WHETHER ARISING OUT OF BREACH OF CONTRACT, TORT (INCLUDING, WITHOUT LIMITATION, NEGLIGENCE), STRICT LIABILITY, INDEMNITY, CONTRIBUTION OR OTHERWISE.**

CUSTOMER SERVICE DESCRIPTION

In order to maintain safe and trouble-free operation of the Product and to prevent the incurrence of unnecessary costs and expenses, Advantest recommends a regular preventive maintenance program under its maintenance agreement.

Advantest's maintenance agreement provides the Purchaser on-site and off-site maintenance, parts, maintenance machinery, regular inspections, and telephone support and will last a maximum of ten years from the date the delivery of the Product. For specific details of the services provided under the maintenance agreement, please contact the nearest Advantest office listed at the end of this Operation Manual or Advantest's sales representatives.

Some of the components and parts of this Product have a limited operating life (such as, electrical and mechanical parts, fan motors, unit power supply, etc.). Accordingly, these components and parts will have to be replaced on a periodic basis. If the operating life of a component or part has expired and such component or part has not been replaced, there is a possibility that the Product will not perform properly. Additionally, if the operating life of a component or part has expired and continued use of such component or part damages the Product, the Product may not be repairable. Please contact the nearest Advantest office listed at the end of this Operation Manual or Advantest's sales representatives to determine the operating life of a specific component or part, as the operating life may vary depending on various factors such as operating condition and usage environment.

SALES & SUPPORT OFFICES

Advantest Korea Co., Ltd.

22BF, Kyobo KangNam Tower,
1303-22, Seocho-Dong, Seocho-Ku, Seoul #137-070, Korea
Phone: +82-2-532-7071
Fax: +82-2-532-7132

Advantest (Suzhou) Co., Ltd.

Shanghai Branch Office:
Bldg. 6D, NO.1188 Gumei Road, Shanghai, China 201102 P.R.C.
Phone: +86-21-6485-2725
Fax: +86-21-6485-2726

Shanghai Branch Office:
406/F, Ying Building, Quantum Plaza, No. 23 Zhi Chun Road,
Hai Dian District, Beijing,
China 100083
Phone: +86-10-8235-3377
Fax: +86-10-8235-6717

Advantest (Singapore) Pte. Ltd.

438A Alexandra Road, #08-03/06
Alexandra Technopark Singapore 119967
Phone: +65-6274-3100
Fax: +65-6274-4055

Advantest America, Inc.

3201 Scott Boulevard, Suite, Santa Clara, CA 95054, U.S.A
Phone: +1-408-988-7700
Fax: +1-408-987-0691

ROHDE & SCHWARZ Europe GmbH

Mühldorfstraße 15 D-81671 München, Germany
(P.O.B. 80 14 60 D-81614 München, Germany)
Phone: +49-89-4129-13711
Fax: +49-89-4129-13723

ADVANTEST®

<http://www.advantest.co.jp>